

ASCO™ Pneumatic Straight Seat Valves

3-way, Pressure Operated, Stainless Steel Body
Plastic or Stainless Steel Actuator, 1/2" to 2" Tapped

3/2
Series
390

Features and Benefits

- Suitable for broad range of industrial machines and manufacturing process.
- High reliability, long service life and exceptional and repeatable tight shutoff
- Adjustable actuator enables 360° access to pilot port
- Modular design provides exceptional flexibility
- Large piloting orifice and low hysteresis creates fast cycle times
- Anti-water hammer design and back pressure resistant
- Extensive range of actuators, options, certifications and accessories
- High performance, maintenance-free actuator and stuffing box
- Easy and fast maintenance without the need to remove valve body from pipework

General

Differential pressure	See Specification section [1 bar = 100 kPa]
Vacuum	10 ⁻² mbar (10 ⁻² Torr/mm Hg)
Maximum allowable pressure	16 bar (240 psi)
Ambient temperature range	
Plastic actuator	-10°C to +60°C (14°F to 140°F)
Stainless steel actuator	-20°C to +70°C (-4°F to 158°F)
Maximum viscosity	800 cSt (mm ² /s) (2.700 SSU)
Pilot fluid	Filtered air or water
Maximum pilot pressure	10 bar (150 psi)
Minimum pilot pressure	See Specifications section
Response time	See dedicated pilot catalog pages

Fluids (*)	Temperature range (TS) ⁽¹⁾	Disc seal (*)
Up to DN 50: air and gas groups 1 and 2 All DN: liquids and steam groups 1 and 2	Plastic actuator: -10°C to +184°C (14°F to 360°F) Stainless steel actuator: -20°C to 140°C (-4°F to 184°F) WSF option: -10°C to +184°C (14°F to 360°F)	PTFE

Materials of components in contact with fluid

(*) Ensure that compatibility of materials in contact with fluids is verified.

	Plastic actuator	Stainless steel actuator
Body	Stainless steel AISI 316L	Stainless steel AISI 316L
Stuffing box housing	Stainless steel AISI 316L	Stainless steel AISI 316L
Stem	Stainless steel AISI 431	Stainless steel AISI 431
Disc	Stainless steel AISI 316L	Stainless steel AISI 316L
Disc seal	PTFE	PTFE
Wiper seal	FPM	FPM
Stuffing box packing	PTFE	PTFE
Valve body seal	PTFE	PTFE

Other components

Actuator	Glass fiber filled PA or stainless steel AISI 316L
Optical position indicator	PA 12

Certifications and Approvals

- Pressure Equipment Directive 2014/68/EU, Category 1 (DN > 25) or article 4.3 (DN ≤ 25)
- Functional Safety of Machinery: EN ISO 13849-1
- Reach compliant
- IEC 61508 Standard (2010 route 2_H version) certified with integrity levels: SIL 2 for HFT = 0
- Valves satisfy all relevant EU and EAC directives
- RoHS compatible

Options ⁽²⁾

- Oxygen service pressure limited to 15 bar (220 psi), ambient and media temperatures limited to +60°C (140°F)
- Explosive atmospheres, ATEX and IECEx compliant
- Medium vacuum service up to 10⁻³ mb (10⁻³ Torr)
- Pilots (see dedicated catalog pages)
- Large range of switch boxes (see dedicated catalog pages)
- Valve body material composition certificate 3.1

⁽¹⁾ The minimum ambient temperature of the valve is determined by the limitations of minimum temperature indicated.

⁽²⁾ See Choice of options and accessories (page 7)

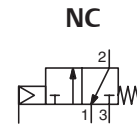

NC function, entry under the disc, 63 mm plastic actuator

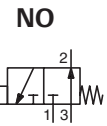
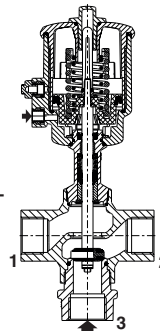

NO function, entry under the disc, 63 mm plastic actuator

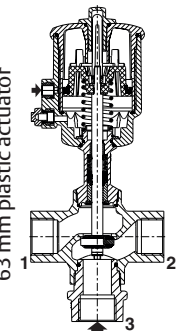

NC function, entry under the disc, 63 mm stainless steel actuator

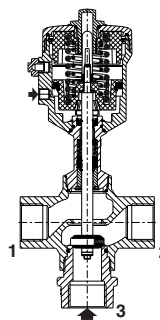

NO function, entry under the disc, 63 mm stainless steel actuator

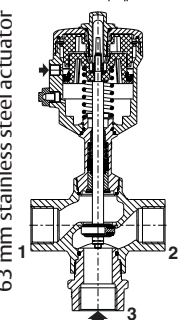

01536CB-2021/RO1
Availability, design and specifications are subject to change without notice. All rights reserved.

Specifications

Piping (ISO 6708)		Flow coefficient				Pilot pressure		Operating pressure differential				Actuator diameter		Catalog number	
Pipe size	DN	Kv (Cv)				bar (psi)		bar (psi)				Actuator diameter (mm)	Dimensions / Type ⁽¹⁾	Thread type	
		3 → 2		2 → 1		Min.	Max.	Air, inert gas (*)	Water, oil, liquids (*)	Steam ≤ 140°C (≤ 284°F) (*)	(G*)			(NPTF)	
		m³/h (gal/min)	(l/min)	m³/h (gal/min)	(l/min)										
Plastic actuator															
NC - Normally closed, entry under the disc															
1/2"	15	3.5 (4)	58.3	3.7 (4.3)	61.6	2.8 (45)	10 (150)	16 (240)	16 (240)	10 (150)	63	01	E390D025USA0000	8390D0268SA0000	
3/4"	20	7.6 (8.8)	126.6	6.7 (7.8)	111.6	4.5 (70)	10 (150)	16 (240)	16 (240)	10 (150)	63	01	E390D035USA0000	8390D0368SA0000	
1"	25	17.7 (20.5)	295	12.7 (14.7)	211.6	4.5 (70)	10 (150)	10 (150)	10 (150)	10 (150)	63	01	E390D045USA0000	8390D0468SA0000	
						4.5 (70)	10 (150)	16 (240)	16 (240)	10 (150)	90	02	E390D04BUSA0000	8390D04C8SA0000	
						2.8 (45)	10 (150)	6 (90)	6 (90)	6 (90)	63	01	E390D745USA0000	8390D7468SA0000	
						2.8 (45)	10 (150)	12 (180)	12 (180)	10 (150)	90	02	E390D74BUSA0000	8390D74C8SA0000	
1 1/4"	32	25 (29)	416	18 (20.9)	300	4.5 (70)	10 (150)	6 (90)	6 (90)	6 (90)	63	01	E390D055USA0000	8390D0568SA0000	
								12 (180)	12 (180)	10 (150)	90	02	E390D05BUSA0000	8390D05C8SA0000	
1 1/2"	40	33.1 (38.4)	551	24.3 (28.2)	404.8	4.5 (70)	10 (150)	4 (60)	4 (60)	4 (60)	63	01	E390D065USA0000	8390D0668SA0000	
								8 (120)	8 (120)	8 (120)	90	02	E390D06BUSA0000	8390D06C8SA0000	
						4 (60)	10 (150)	16 (240)	16 (240)	10 (150)	125	03	E390D06HUSA0000	8390D06J8SA0000	
2"	50	38.9 (45.1)	648	33.8 (39.2)	563	4.5 (70)	10 (150)	6 (90)	6 (90)	6 (90)	90	02	E390D07BUSA0000	8390D07C8SA0000	
						4 (60)	10 (150)	10 (150)	10 (150)	10 (150)	125	03	E390D07HUSA0000	8390D07J8SA0000	
NO - Normally open, entry under the disc															
1/2"	15	3.5 (4)	58.3	3.7 (4.3)	61.6	II (*)	10 (150)	16 (240)	16 (240)	10 (150)	63	01	E390D125USA0000	8390D1268SA0000	
3/4"	20	7.6 (8.8)	126.6	6.7 (7.8)	111.6	II (*)	10 (150)	16 (240)	16 (240)	10 (150)	63	01	E390D135USA0000	8390D1368SA0000	
1"	25	17.7 (20.5)	295	12.7 (14.7)	211.6	II (*)	10 (150)	16 (240)	16 (240)	10 (150)	63	01	E390D145USA0000	8390D1468SA0000	
1 1/4"	32	25 (29)	416	18 (20.9)	300	II (*)	10 (150)	16 (240)	16 (240)	10 (150)	63	01	E390D155USA0000	8390D1568SA0000	
						III (*)	10 (150)	16 (240)	16 (240)	10 (150)	90	02	E390D15BUSA0000	8390D15C8SA0000	
1 1/2"	40	33.1 (38.4)	551	24.3 (28.2)	404.8	II (*)	10 (150)	11 (165)	11 (165)	10 (150)	63	01	E390D165USA0000	8390D1668SA0000	
						III (*)	10 (150)	16 (240)	16 (240)	10 (150)	90	02	E390D16BUSA0000	8390D16C8SA0000	
						IV (*)	10 (150)	16 (240)	16 (240)	10 (150)	125	03	E390D16HUSA0000	8390D16J8SA0000	
2"	50	38.9 (45.1)	648	33.8 (39.2)	563	II (*)	10 (150)	7 (105)	7 (105)	7 (105)	63	01	E390D175USA0000	8390D1768SA0000	
						III (*)	10 (150)	13 (195)	13 (195)	10 (150)	90	02	E390D17BUSA0000	8390D17C8SA0000	
						IV (*)	10 (150)	16 (240)	16 (240)	10 (150)	125	03	E390D17HUSA0000	8390D17J8SA0000	

(*) Ensure that compatibility of materials in contact with fluids is verified.
 (*) Minimum pilot pressure varies with differential pressure, see page 6
 (1) For dimensions, see drawing(s) for each construction type on the following page(s).

Specifications

Piping (ISO 6708)		Flow coefficient				Pilot pressure		Operating pressure differential			Actuator diameter		Catalog number	
Pipe size	DN	Kv (Cv)				bar (psi)		bar (psi)			Actuator diameter (mm)	Dimensions / Type (1)	Thread type	
		3 → 2		2 → 1		Min.	Max.	Air, inert gas (*)	Water, oil, liquids (*)	Steam ≤ 140°C (≤ 284°F)			(G*)	(NPTF)
		m ³ /h (gal/min)	l/min	m ³ /h (gal/min)	l/min									
Stainless steel actuator														
NC - Normally closed, entry under the disc														
1/2"	15	3.5 (4)	58.3	3.7 (4.3)	61.6	2.8 (45)	10 (150)	16 (240)	16 (240)	10 (150)	63	01	E390D02TUSA0000	8390D02U8SA0000
3/4"	20	7.6 (8.8)	126.6	6.7 (7.8)	111.6	4.5 (70)	10 (150)	16 (240)	16 (240)	10 (150)	63	01	E390D03TUSA0000	8390D03U8SA0000
1"	25	17.7 (20.5)	295	12.7 (14.7)	211.6	4.5 (70)	10 (150)	10 (150)	10 (150)	10 (150)	63	01	E390D04TUSA0000	8390D04U8SA0000
						4.5 (70)	10 (150)	16 (240)	16 (240)	10 (150)	90	02	E390D04XUSA0000	8390D04Y8SA0000
						2.8 (45)	10 (150)	6 (90)	6 (90)	6 (90)	63	01	E390D74TUSA0000	8390D74U8SA0000
						2.8 (45)	10 (150)	12 (180)	12 (180)	10 (150)	90	02	E390D74XUSA0000	8390D74Y8SA0000
1 1/4"	32	25 (29)	416	18 (20.9)	300	4.5 (70)	10 (150)	6 (90)	6 (90)	6 (90)	63	01	E390D05TUSA0000	8390D05U8SA0000
								12 (180)	12 (180)	10 (150)	90	02	E390D05XUSA0000	8390D05Y8SA0000
1 1/2"	40	33.1 (38.4)	551	24.3 (28.2)	404.8	4.5 (70)	10 (150)	4 (60)	4 (60)	4 (60)	63	01	E390D06TUSA0000	8390D06U8SA0000
								8 (120)	8 (120)	8 (120)	90	02	E390D06XUSA0000	8390D06Y8SA0000
2"	50	38.9 (45.1)	648	33.8 (39.2)	563	4.5 (70)	10 (150)	6 (90)	6 (90)	6 (90)	90	02	E390D07XUSA0000	8390D07Y8SA0000
NO - Normally open, entry under the disc														
1/2"	15	3.5 (4)	58.3	3.7 (4.3)	61.6	II(*)	10 (150)	16 (240)	16 (240)	10 (150)	63	01	E390D12TUSA0000	8390D12U8SA0000
3/4"	20	7.6 (8.8)	126.6	6.7 (7.8)	111.6	II(*)	10 (150)	16 (240)	16 (240)	10 (150)	63	01	E390D13TUSA0000	8390D13U8SA0000
1"	25	17.7 (20.5)	295	12.7 (14.7)	211.6	II(*)	10 (150)	16 (240)	16 (240)	10 (150)	63	01	E390D14TUSA0000	8390D14U8SA0000
1 1/4"	32	25 (29)	416	18 (20.9)	300	II(*)	10 (150)	16 (240)	16 (240)	10 (150)	63	01	E390D15TUSA0000	8390D15U8SA0000
						III(*)	10 (150)	16 (240)	16 (240)	10 (150)	90	02	E390D15XUSA0000	8390D15Y8SA0000
1 1/2"	40	33.1 (38.4)	551	24.3 (28.2)	404.8	II(*)	10 (150)	11 (165)	11 (165)	10 (150)	63	01	E390D16TUSA0000	8390D16U8SA0000
						III(*)	10 (150)	16 (240)	16 (240)	10 (150)	90	02	E390D16XUSA0000	8390D16Y8SA0000
2"	50	38.9 (45.1)	648	33.8 (39.2)	563	II(*)	10 (150)	7 (105)	7 (105)	7 (105)	63	01	E390D17TUSA0000	8390D17U8SA0000
						III(*)	10 (150)	13 (195)	13 (195)	10 (150)	90	02	E390D17XUSA0000	8390D17Y8SA0000

(*) Ensure that compatibility of materials in contact with fluids is verified.
 (*) Minimum pilot pressure varies with differential pressure, see page 6
 (1) For dimensions, see drawing(s) for each construction type on the following page(s).

01536GB-2021/R01
Availability, design and specifications are subject to change without notice. All rights reserved.

Product selection guide

Configurator - CAD Files

PRODUCT CODE
E 390 D 0 3 5 U S A00 00

Connection type

- E** = ISO 228/1 & ISO 7/1
(combination thread, G*)
- 8** = NPTF (ANSI B 1.20.3)
- J** = ISO 7/1 «Rc»

Product series

390

Revision letter

D = Initial release

Function

- 0** = Normally Closed
- 1** = Normally Open
- 7** = Normally Closed - Low pilot pressure

Nominal diameter

- 2** = DN15 - 1/2"
- 3** = DN20 - 3/4"
- 4** = DN25 - 1"
- 5** = DN32 - 1 1/4"
- 6** = DN40 - 1 1/2"
- 7** = DN50 - 2"

Actuator diameter - Piloting connections

- 5** = 63 mm plastic - G 1/8"
- 6** = 63 mm plastic - NPTF 1/8"
- B** = 90 mm plastic - G 1/4"
- C** = 90 mm plastic - NPTF 1/4"
- H** = 125 mm plastic - G 1/4"
- J** = 125 mm plastic - NPTF 1/4"
- T** = 63 mm stainless steel - G 1/8"
- U** = 63 mm stainless steel - NPT 1/8"
- X** = 90 mm stainless steel - G 1/4"
- Y** = 90 mm stainless steel - NPT 1/4"

Options

- A00** = Without
- PFB** = Prepared for signalling box mounting ⁽¹⁾
- AT1** = ATEX/IECEx 1/21 zones ⁽¹⁾
- AT0** = ATEX/IECEx 0/20 zones ⁽¹⁾
- 02S** = Oxygen service 15 bar / 60°C
- 125** = CULTR certification (EAC Ex 1/21 zones) for product
- STL** = Stroke limiter for opening ⁽¹⁾
- TC6** = Test tightness class VI ⁽¹⁾
- VAC** = Industrial vacuum 10⁻³ mbar ⁽¹⁾
- M31** = Stainless steel valve body material certificate 3.1 ⁽¹⁾
- 327** = Adaptation for pilot 327
- WSP** = PTFE wiper seal
- WSF** = FPM piston seal and steam using up to +184°C / 360°F
- 11B** = Manual safety device ⁽¹⁾
- SSF** = Stainless steel insert for plastic actuator

Valve body and disc seal material

- S** = Stainless steel body
- Y** = All 316L

Port type 1 and 2 and 3rd way

- U** = 1st and 2nd ways threaded and 3rd way ISO 228/1 and ISO 7/1
- V** = 1st and 2nd ways threaded and 3rd way ISO 7/1 «Rc»
- 8** = 1st and 2nd ways threaded and 3rd way NPTF (ANSI B 1.20.3)

⁽¹⁾ See "Choice of options and accessories", pages 7 and 8

Repair Kits and Service Parts

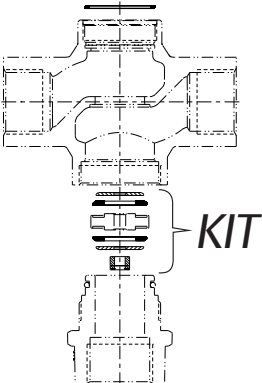
	DN		Spare parts kits no. 63-90-125 mm	
			FPM	PTFE 25% carbon
	15	FPM	M39054935100700	M39054935100100
	20	FPM	M39054935100800	M39054935100200
	25	FPM	M39054935100900	M39054935100300
	32	FPM	M29054935101800	M39054935100400
	40	FPM	M39054935101000	M39054935100500
	50	FPM	M39054935101100	M39054935100600

View showing the function / actuator / flow direction

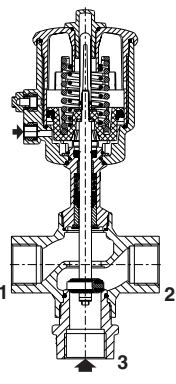
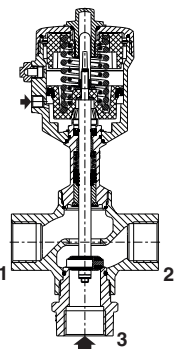
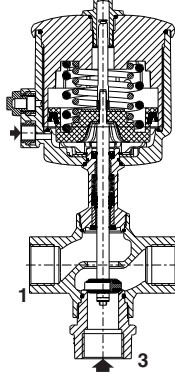
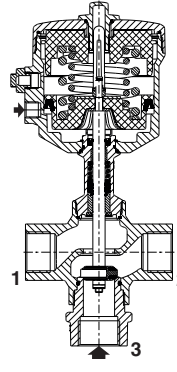
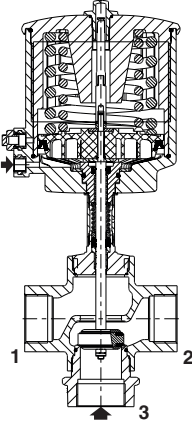
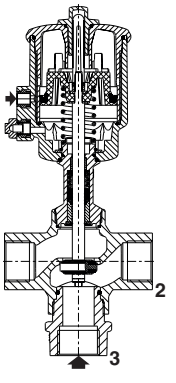
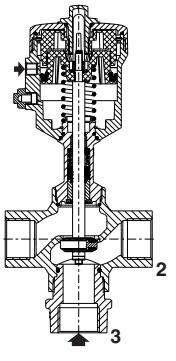
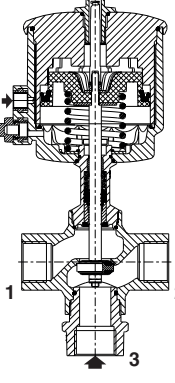
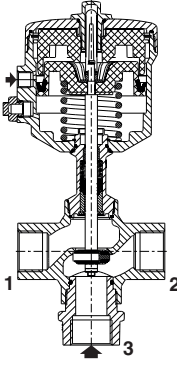
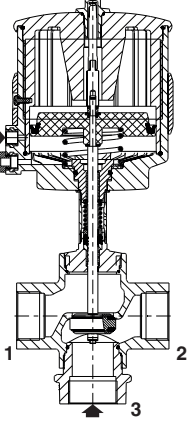
63 mm actuator		90 mm actuator		125 mm actuator
Plastic	Stainless steel	Plastic	Stainless steel	Plastic
NC - Normally closed, entry under the disc				
				
NO - Normally open, entry under the disc				
				

01536GB-2021/R01
Availability, design and specifications are subject to change without notice. All rights reserved.

Selection of the minimum pilot pressure

NO - Normally open, entry under the disc

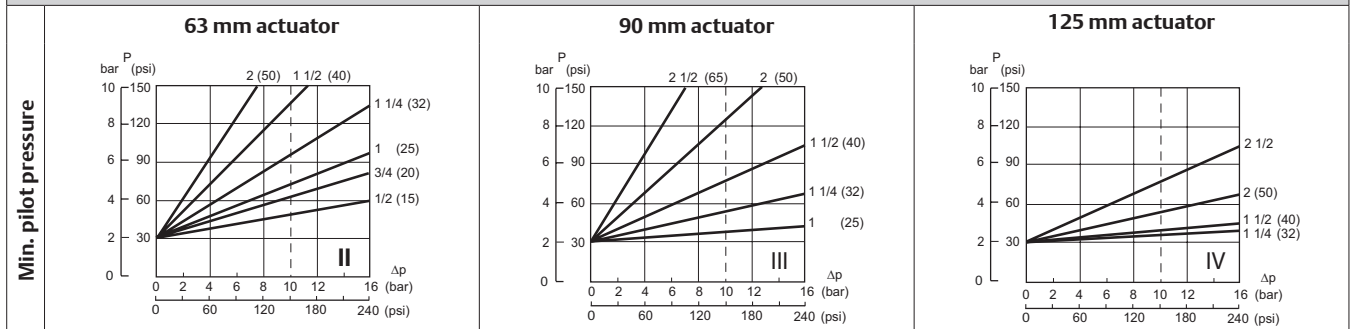





Installation

- Valves can be mounted in any position without affecting operation
- Possibility to interchange actuators (sizes/functions) on the same body
- Adjustable actuator enables 360° access to pilot port
- Compatible with ASTM 1, 2 and 3 oils
- Pipe connections (G*) have standard combination thread according to ISO 228/1 and ISO 7/1
- Thread connection (NPTF) has a standard thread according to ANSI B 1.20.3
- Thread connection (Rc) has a standard thread according to ISO 7/1
- Pilot thread connection (G) or (NPTF) or (NPT) has a standard thread according to ISO 228/1 or ANSI B 1.20.3 or ANSI B1.20.1
- Installation/maintenance instructions in multiple languages are available on our website

01536GB-2021/R01
Availability, design and specifications are subject to change without notice. All rights reserved.

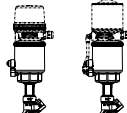





Choice of options and accessories

Options	NC	NO	Actuator diameter compatibility (mm)																																																																								
	Fluid entry under the disc	Fluid entry under the disc	63	90	125																																																																						
ATO	●	●	●	●	●	<p>ATEX/IECEX</p> <ul style="list-style-type: none"> 3/2 valves NC/NO designed for use in potentially explosive atmospheres in accordance with ATEX-Directive 2014/34/EU EC type examination certificate no.: LCIE 20 ATEX 3037 X IECEX Certificate of Conformity no.: IECEX LCIE 20.0025X Compliance with the Essential Health and Safety Requirements of the ATEX Directive has been assured by compliance with European Standards EN ISO 80079-36 and EN ISO 80079-37 Recommended for applications in the chemical, oil, gas and paint coating industries etc. <p>ATEX-Directive 2014/34/EU, category 1</p> <table border="1"> <thead> <tr> <th colspan="7">Classification (zones) Category 1</th> </tr> <tr> <th colspan="3">Dusts</th> <th colspan="3">Gas</th> <th rowspan="2">Safety code</th> </tr> <tr> <th>IIIA</th> <th>IIIB</th> <th>IIIC</th> <th>IIA</th> <th>IIB</th> <th>IIC</th> </tr> </thead> <tbody> <tr> <td colspan="3">Zone 20</td> <td colspan="3">Zone 0</td> <td> ⓧ II 1G Ex h IIC T* Ga ⓧ II 1D Ex h IIIC T*°C Da </td> </tr> </tbody> </table> <table border="1"> <thead> <tr> <th colspan="2">1GD</th> <th colspan="2">Plastic actuator</th> <th colspan="2">Metallic actuator</th> </tr> <tr> <th>T*°C</th> <th>T*</th> <th>Ts amb</th> <th>T fluid</th> <th>Ts amb</th> <th>T fluid</th> </tr> </thead> <tbody> <tr> <td>300°C</td> <td>T2</td> <td>-</td> <td>-</td> <td>80°C</td> <td>220°C</td> </tr> <tr> <td>200°C</td> <td>T3</td> <td>60°C</td> <td>145°C</td> <td>80°C</td> <td>149°C</td> </tr> <tr> <td>135°C</td> <td>T4</td> <td>60°C</td> <td>93°C</td> <td>80°C</td> <td>97°C</td> </tr> <tr> <td>100°C</td> <td>T5</td> <td>60°C</td> <td>65°C</td> <td>70°C</td> <td>69°C</td> </tr> <tr> <td>85°C</td> <td>T6</td> <td>60°C</td> <td>53°C</td> <td>60°C</td> <td>57°C</td> </tr> </tbody> </table>	Classification (zones) Category 1							Dusts			Gas			Safety code	IIIA	IIIB	IIIC	IIA	IIB	IIC	Zone 20			Zone 0			ⓧ II 1G Ex h IIC T* Ga ⓧ II 1D Ex h IIIC T*°C Da	1GD		Plastic actuator		Metallic actuator		T*°C	T*	Ts amb	T fluid	Ts amb	T fluid	300°C	T2	-	-	80°C	220°C	200°C	T3	60°C	145°C	80°C	149°C	135°C	T4	60°C	93°C	80°C	97°C	100°C	T5	60°C	65°C	70°C	69°C	85°C	T6	60°C	53°C	60°C	57°C
						Classification (zones) Category 1																																																																					
Dusts			Gas			Safety code																																																																					
IIIA	IIIB	IIIC	IIA	IIB	IIC																																																																						
Zone 20			Zone 0			ⓧ II 1G Ex h IIC T* Ga ⓧ II 1D Ex h IIIC T*°C Da																																																																					
1GD		Plastic actuator		Metallic actuator																																																																							
T*°C	T*	Ts amb	T fluid	Ts amb	T fluid																																																																						
300°C	T2	-	-	80°C	220°C																																																																						
200°C	T3	60°C	145°C	80°C	149°C																																																																						
135°C	T4	60°C	93°C	80°C	97°C																																																																						
100°C	T5	60°C	65°C	70°C	69°C																																																																						
85°C	T6	60°C	53°C	60°C	57°C																																																																						
ATO	●	●	●	●	●																																																																						
AT1	●	●	●	●	●	<p>ATEX-Directive 2014/34/EU, category 2</p> <table border="1"> <thead> <tr> <th colspan="7">Classification (zones) Category 2</th> </tr> <tr> <th colspan="3">Dusts</th> <th colspan="3">Gas</th> <th rowspan="2">Safety code</th> </tr> <tr> <th>IIIA</th> <th>IIIB</th> <th>IIIC</th> <th>IIA</th> <th>IIB</th> <th>IIC</th> </tr> </thead> <tbody> <tr> <td colspan="3">Zone 21</td> <td colspan="3">Zone 1</td> <td> ⓧ II 2G Ex h IIC T* Gb X ⓧ II 2D Ex h IIIC T*°C Db X </td> </tr> </tbody> </table> <table border="1"> <thead> <tr> <th colspan="2">2GD</th> <th colspan="2">Plastic actuator</th> <th colspan="2">Metallic actuator</th> </tr> <tr> <th>T*°C</th> <th>T*</th> <th>Ts amb</th> <th>T fluid</th> <th>Ts amb</th> <th>T fluid</th> </tr> </thead> <tbody> <tr> <td>300°C</td> <td>T2</td> <td>-</td> <td>-</td> <td>80°C</td> <td>220°C</td> </tr> <tr> <td>200°C</td> <td>T3</td> <td>60°C</td> <td>180°C</td> <td>80°C</td> <td>184°C</td> </tr> <tr> <td>135°C</td> <td>T4</td> <td>60°C</td> <td>115°C</td> <td>80°C</td> <td>119°C</td> </tr> <tr> <td>100°C</td> <td>T5</td> <td>60°C</td> <td>80°C</td> <td>70°C</td> <td>80°C</td> </tr> <tr> <td>85°C</td> <td>T6</td> <td>60°C</td> <td>60°C</td> <td>60°C</td> <td>60°C</td> </tr> </tbody> </table> <p>T*°C = Surface temperature T* = Temperature class Ts amb = Ambient temperature T fluid = Fluid temperature</p>	Classification (zones) Category 2							Dusts			Gas			Safety code	IIIA	IIIB	IIIC	IIA	IIB	IIC	Zone 21			Zone 1			ⓧ II 2G Ex h IIC T* Gb X ⓧ II 2D Ex h IIIC T*°C Db X	2GD		Plastic actuator		Metallic actuator		T*°C	T*	Ts amb	T fluid	Ts amb	T fluid	300°C	T2	-	-	80°C	220°C	200°C	T3	60°C	180°C	80°C	184°C	135°C	T4	60°C	115°C	80°C	119°C	100°C	T5	60°C	80°C	70°C	80°C	85°C	T6	60°C	60°C	60°C	60°C
						Classification (zones) Category 2																																																																					
Dusts			Gas			Safety code																																																																					
IIIA	IIIB	IIIC	IIA	IIB	IIC																																																																						
Zone 21			Zone 1			ⓧ II 2G Ex h IIC T* Gb X ⓧ II 2D Ex h IIIC T*°C Db X																																																																					
2GD		Plastic actuator		Metallic actuator																																																																							
T*°C	T*	Ts amb	T fluid	Ts amb	T fluid																																																																						
300°C	T2	-	-	80°C	220°C																																																																						
200°C	T3	60°C	180°C	80°C	184°C																																																																						
135°C	T4	60°C	115°C	80°C	119°C																																																																						
100°C	T5	60°C	80°C	70°C	80°C																																																																						
85°C	T6	60°C	60°C	60°C	60°C																																																																						
AT1	●	●	●	●	●																																																																						
PFB	●	●	●	●	●	 <p>Prepared for signalling box mounting</p>																																																																					
-	●	●	●	●	●	 <p>See the dedicated catalogue pages</p> <ul style="list-style-type: none"> The signaling box fits on compatible actuators to indicate whether the valve is open or closed 																																																																					

When a combination of several options are selected (using the product configurator on our website) you will be provided with a specific combination code

01536GB-2021/R01
Availability, design and specifications are subject to change without notice. All rights reserved.

Choice of options and accessories

Options	NC	NO	Actuator diameter compatibility (mm)				
	Fluid entry under the disc	Fluid entry under the disc	63	90	125		
-	•	•	•	•	•		See the dedicated catalogue pages <ul style="list-style-type: none"> • Signaling unit with reed switch or magneto-resistive (MR) detectors for compatible actuators
02S	•	•	•	•	•		Oxygen service <ul style="list-style-type: none"> • Special grease and cleaning • Pressure limited to 15 bar/temperature limited to +60°C
STL	•	-	•	•	•		Stroke limiter for opening
TC6	•	•	•	•	•		Test tightness class VI (FCI 70-2)
VAC	•	•	•	•	•		Industrial vacuum 10 ⁻³ mbar (FPM disc)
M31	•	•	•	•	•		Stainless steel valve body material certificate 3.1
327	•	•	•	•	-		Adaptation for pilot 327 (1/4", basic flow) (stainless steel actuator only) See dedicated pilot catalog pages
WSP	•	•	•	•	•		PTFE wiper seal (for filtered / cleaned medium)
WSF	•	•	•	•	-		FPM piston seal
11B	•	-	•	•	•		Manual safety device <ul style="list-style-type: none"> • Allows opening of a de-energized valve • For normally closed (NC) valves only (under/above the disc)

• Available feature - Not available

When a combination of several options are selected (using the product configurator on our website) you will be provided with a specific combination code

Choice of pilots

(For information about pilots, please consult the dedicated catalog pages)

ASCO™ Pneumatic Straight Seat Valves

Dimensions mm (inches), Weight kg (Lbs)

Configurator - CAD Files



TYPE 01
63 mm plastic actuator
Fluid entry:
under the disc at 3

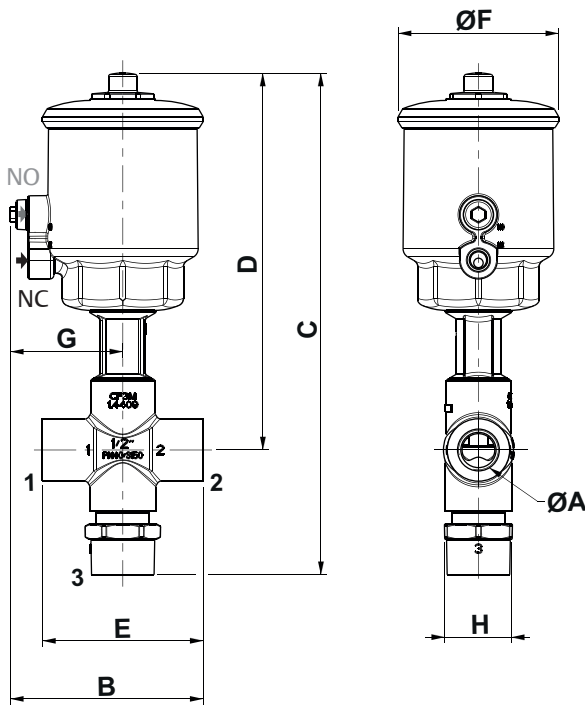

NC
entry under the
disc at 3

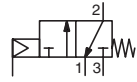

NO
entry under the
disc at 3

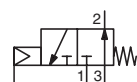

Manual safety device (11B)
(NC only)

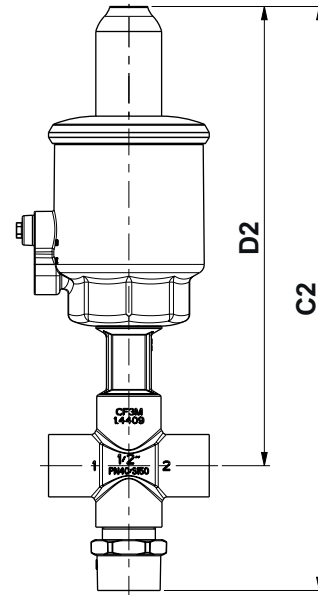

NAMUR plate
(NC / NO)

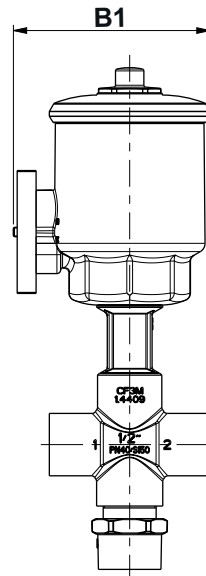
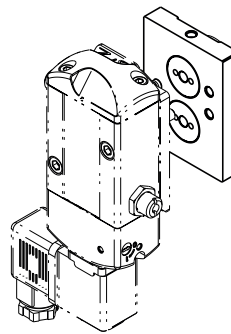

Type	Actuator diameter	ØA		B	B1	C	C2	D	D2	E	ØF	G	H	Weight ⁽¹⁾	
01	63 mm	G* 1/2"	mm	102	104	265.5	309	199.5	243	85	85	59.5	36	1.6	kg
		NPTF 1/2"	(in)	4.016	4.094	10.453	12.165	7.854	9.567	3.346	3.346	2.343	1.417	3.5	(Lbs)
		G* 3/4"	mm	114.5	116.5	268	311.5	198.5	242	110	85	59.5	42	2.1	kg
		NPTF 3/4"	(in)	4.508	4.587	10.551	12.264	7.815	9.528	4.331	3.346	2.343	1.654	4.6	(Lbs)
		G* 1"	mm	119.5	121.5	283.5	327	207	250.5	120	85	59.5	50	2.5	kg
		NPTF 1"	(in)	4.705	4.783	11.161	12.874	8.150	9.862	4.724	3.346	2.343	1.969	5.5	(Lbs)
		G* 1 1/4"	mm	132	134	302	345.5	223.5	267	145	85	59.5	60	3.5	kg
		NPTF 1 1/4"	(in)	5.197	5.276	11.890	13.602	8.799	10.512	5.709	3.346	2.343	2.362	7.7	(Lbs)
		G* 1 1/2"	mm	134.5	136.5	307.5	351	221	264.5	150	85	59.5	70	4.3	kg
NPTF 1 1/2"	(in)	5.295	5.374	12.106	13.819	8.701	10.413	5.906	3.346	2.343	2.756	9.5	(Lbs)		

⁽¹⁾ Weight of valve without pilot.
For solenoid pilot valve, see dedicated catalog pages.

01536GB-2021/R01
Availability, design and specifications are subject to change without notice. All rights reserved.

Dimensions mm (inches), Weight kg (Lbs)

Configurator - CAD Files



TYPE 01
63 mm stainless steel actuator
Fluid entry:
under the disc at 3

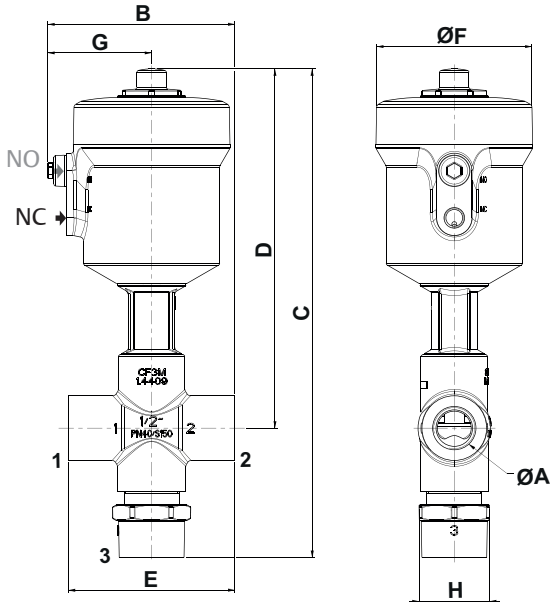

NC
entry under the
disc at 3

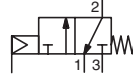

NO
entry under the
disc at 3

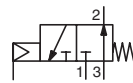

NAMUR plate
(NC / NO)

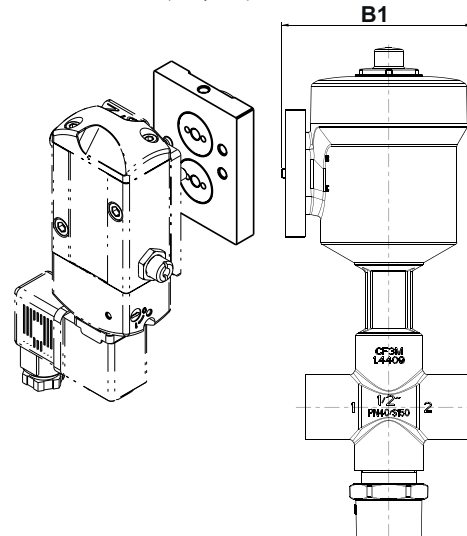

Type	Actuator diameter	ØA		B	B1	C	D	E	ØF	G	H	Weight ⁽¹⁾	
01	63 mm	G* 1/2"	mm	95.5	97.5	249.5	183.5	85	79.5	53	36	2.3	kg
		NPTF 1/2"	(in)	3.760	3.839	9.823	7.224	3.346	3.130	2.087	1.417	5.1	(Lbs)
		G* 3/4"	mm	108	110	252	182.5	110	79.5	53	42	2.7	kg
		NPTF 3/4"	(in)	4.252	4.331	9.921	7.185	4.331	3.130	2.087	1.654	6.0	(Lbs)
		G* 1"	mm	113	115	267.5	191	120	79.5	53	50	3.1	kg
		NPTF 1"	(in)	4.449	4.528	10.531	7.520	4.724	3.130	2.087	1.969	6.8	(Lbs)
		G* 1 1/4"	mm	125.5	127.5	286	208	145	79.5	53	60	4.1	kg
		NPTF 1 1/4"	(in)	4.941	5.020	11.260	8.189	5.709	3.130	2.087	2.362	9.0	(Lbs)
G* 1 1/2"	mm	128	130	291.5	205	150	79.5	53	70	4.9	kg		
NPTF 1 1/2"	(in)	5.039	5.118	11.476	8.071	5.906	3.130	2.087	2.756	10.8	(Lbs)		

⁽¹⁾ Weight of valve without pilot.
For solenoid pilot valve, see dedicated catalog pages.

ASCO™ Pneumatic Straight Seat Valves

Dimensions mm (inches), Weight kg (Lbs)

Configurator - CAD Files



TYPE 02
90 mm plastic actuator
Fluid entry:
under the disc at 3

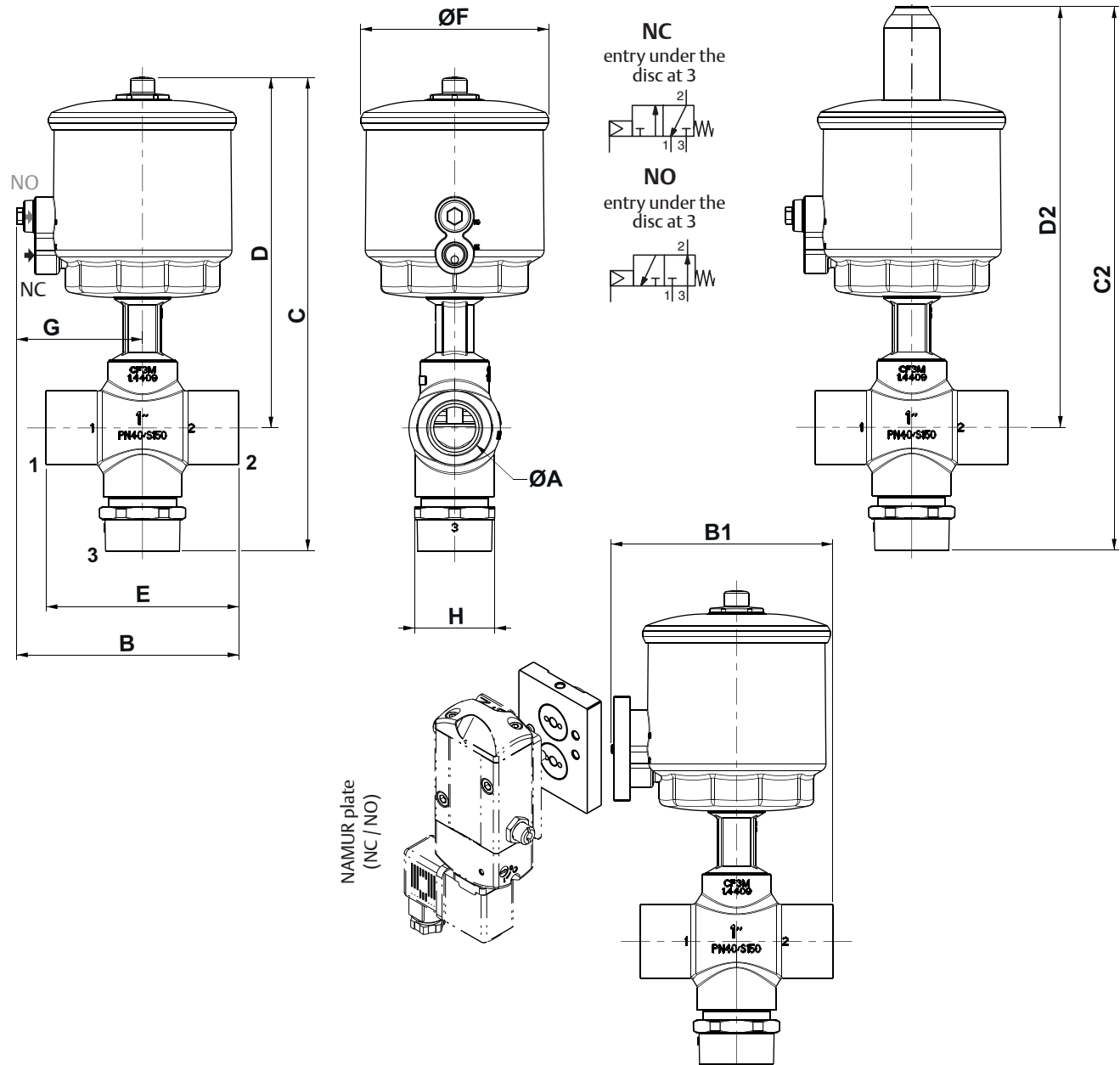

Type	Actuator diameter	ØA		B	B1	C	C2	D	D2	E	ØF	G	H	Weight ⁽¹⁾	
02	90 mm	G* 1"	mm	138.5	138.5	295	338.5	218.5	262	120	117	78.5	50	3.1	kg
		NPTF 1"	(in)	5.453	5.453	11.614	13.327	8.602	10.315	4.724	4.606	3.091	1.969	6.8	(Lbs)
		G* 1 1/4"	mm	151	151	313.5	357	235.5	279	145	117	78.5	60	4.1	kg
		NPTF 1 1/4"	(in)	5.945	5.945	12.343	14.055	9.272	10.984	5.709	4.606	3.091	2.362	9.0	(Lbs)
		G* 1 1/2"	mm	153.5	153.5	319	362.5	232.5	276	150	117	78.5	70	4.9	kg
		NPTF 1 1/2"	(in)	6.043	6.043	12.559	14.272	9.154	10.866	5.906	4.606	3.091	2.756	10.8	(Lbs)
G* 2"	mm	173.5	173.5	333	376.5	243	286.5	190	117	78.5	80	6.3	kg		
NPTF 2"	(in)	6.831	6.831	13.110	14.823	9.567	11.280	7.480	4.606	3.091	3.150	13.9	(Lbs)		

⁽¹⁾ Weight of valve without pilot.
For solenoid pilot valve, see dedicated catalog pages.

01536GB-2021/R01
Availability, design and specifications are subject to change without notice. All rights reserved.

Dimensions mm (inches), Weight kg (Lbs)

Configurator - CAD Files



TYPE 02
90 mm stainless steel actuator
Fluid entry:
under the disc at 3

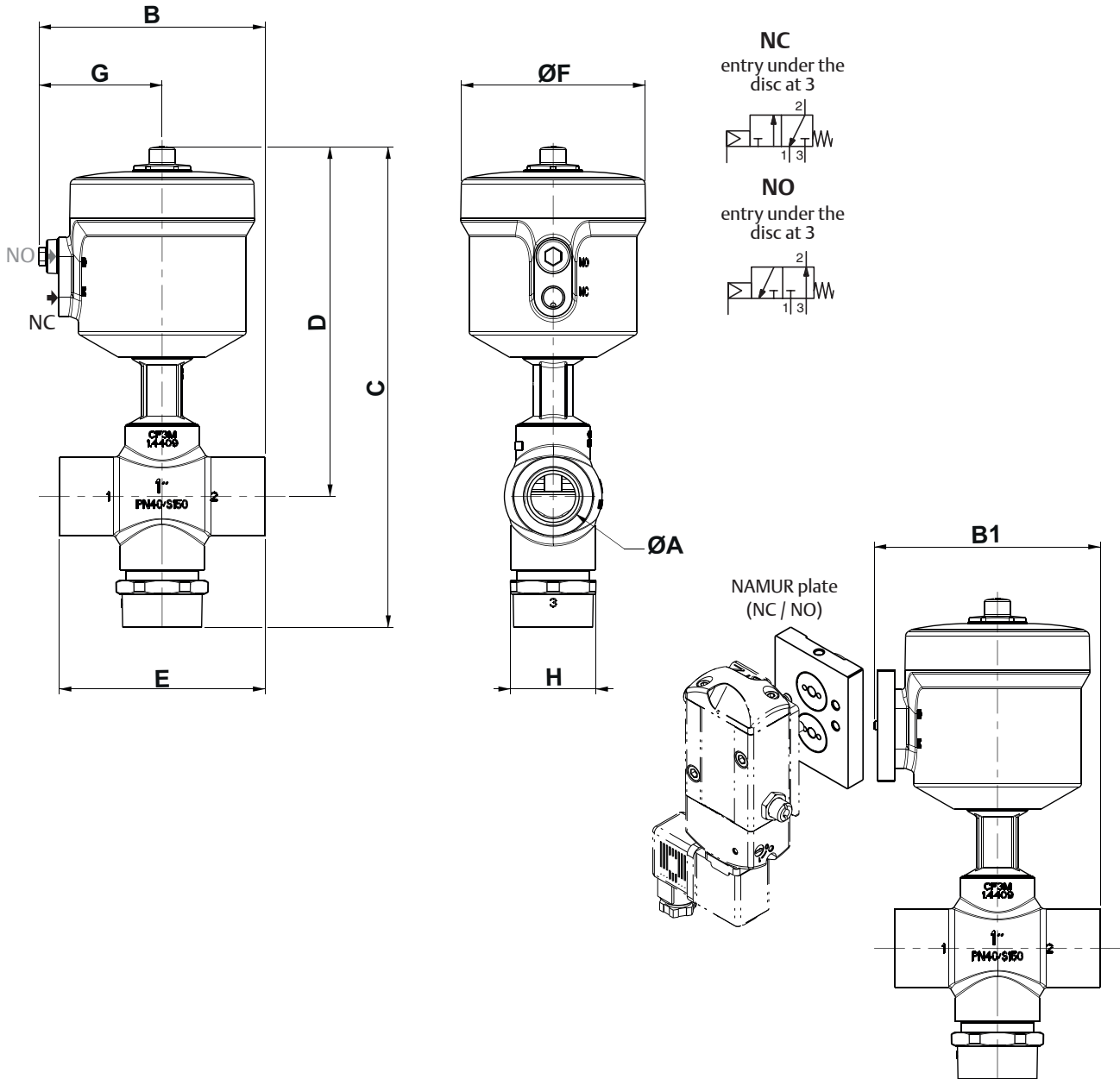

Type	Actuator diameter	ØA		B	B1	C	D	E	ØF	G	H	Weight ⁽¹⁾	
02	90 mm	G* 1"	mm	132	132	281	204.5	120	108	72	50	4.3	kg
		NPTF 1"	(in)	5.197	5.197	11.063	8.051	4.724	4.252	2.835	1.969	9.5	(Lbs)
		G* 1 1/4"	mm	144.5	144.5	299.5	221	145	108	72	60	5.3	kg
		NPTF 1 1/4"	(in)	5.689	5.689	11.791	8.701	5.709	4.252	2.835	2.362	11.7	(Lbs)
		G* 1 1/2"	mm	147	147	305	218.5	150	108	72	70	6.1	kg
		NPTF 1 1/2"	(in)	5.787	5.787	12.008	8.602	5.906	4.252	2.835	2.756	13.4	(Lbs)
		G* 2"	mm	167	167	319	229	190	108	72	80	7.5	kg
NPTF 2"	(in)	6.575	6.575	12.559	9.016	7.480	4.252	2.835	3.150	16.5	(Lbs)		

⁽¹⁾ Weight of valve without pilot.
For solenoid pilot valve, see dedicated catalog pages.

ASCO™ Pneumatic Straight Seat Valves

Dimensions mm (inches), Weight kg (Lbs) 

Configurator - CAD Files



TYPE 03
125 mm plastic actuator
Fluid entry:
under the disc at 3

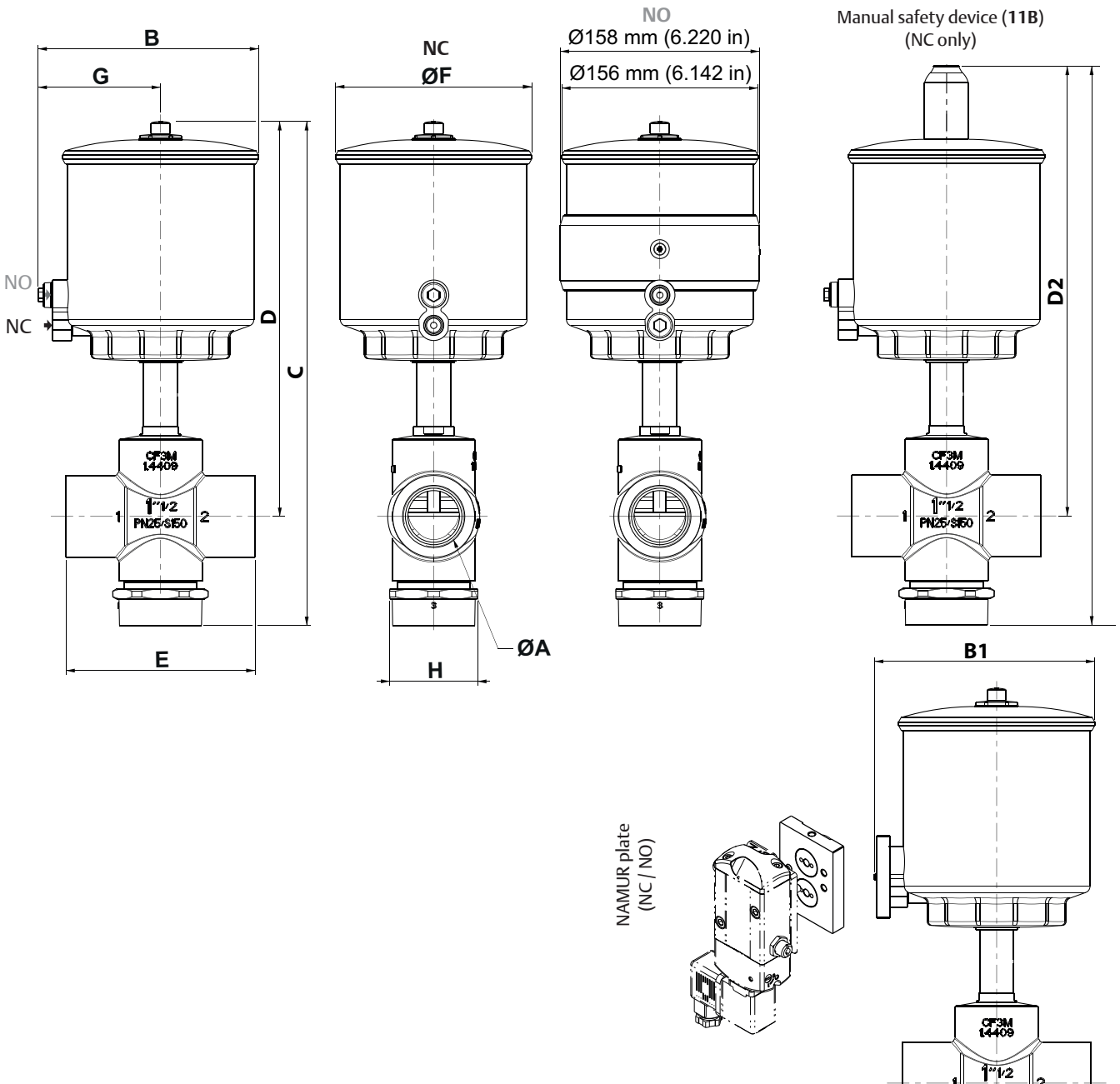
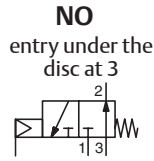
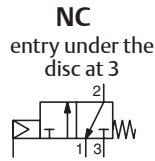

Type	Actuator diameter	ØA		B	B1	C	C2	D	D2	E	ØF		G	H	Weight ⁽¹⁾	
											NC	NO				
03	125 mm	G* 1 1/2"	mm	175	175	400	443.5	313.5	357	150	156	158	97	70	7.9	kg
		NPTF 1 1/2"	(in)	6.890	6.890	15.748	17.461	12.343	14.055	5.906	6.142	6.220	3.819	2.756	17.4	(Lbs)
		G* 2"	mm	192	192	416	459.5	326	369.5	190	156	158	97	80	9.4	kg
		NPTF 2"	(in)	7.559	7.559	16.378	18.091	12.835	14.547	7.480	6.142	6.220	3.819	3.150	20.7	(Lbs)

⁽¹⁾ Weight of valve without pilot.
For solenoid pilot valve, see dedicated catalog pages.

01536GB-2021/R01
Availability, design and specifications are subject to change without notice. All rights reserved.

