

Sensors, Series SN2



AVENTICS™ Sensors, Series SN2























Sensor, Series SN2

- with cable
- without wire end ferrule, tin-plated, 2-pin without wire end ferrule, tin-plated, 3-pin
- Heat resistant
- Reed electronic PNP
- Indirect mounting for series TRB, PRA, ITS, MNI, CSL-RD, ICM, RPC, TRR, FLT, CVI



Ambient temperature min./max.	See table below
Protection class	IP67
Switching point precision	±0,1 mT
Nominal current, actuated state	15 mA
Quiescent current (without load)	10 mA
Min./max. DC operating voltage	See table below
Min./max. AC operating voltage	See table below
LED status display	See table below
Cable length L	3 5 7 10 11 20 m

Technical data

Part No.		Type of contact	Cable sheath	Cable length L
0830100315		Reed	Polyvinyl chloride	3 m
0830100365		Reed	Polyvinyl chloride	3 m
0830100368		Reed	Polyvinyl chloride	3 m
0830100370		Reed	Polyurethane	3 m
0830100316		Reed	-	3 m
0830100373		Reed	-	3 m
0830100367		Reed	Polyurethane	3 m
0830100317		Reed	Thermoplastic elastomer	3 m
0830100366		Reed	Polyvinyl chloride	5 m
0830100369		Reed	Polyvinyl chloride	5 m
0830100327		Reed	Polyvinyl chloride	7 m
0830100325		Reed	Polyvinyl chloride	10 m
0830100326		Reed	Thermoplastic elastomer	11 m
R412004848		Reed	Polyvinyl chloride	20 m
0830100371		Reed	Polyvinyl chloride	3 m
0830100372		Reed	Polyvinyl chloride	5 m
0830100375		electronic PNP	Polyvinyl chloride	3 m
0830100378		electronic PNP	Thermoplastic elastomer	3 m
0830100377		electronic PNP	Polyurethane	3 m
0830100376		electronic PNP	Polyvinyl chloride	5 m

Part No.	Min./max. DC operating voltage	Min./max. AC operating voltage
0830100315	0 ... 60 V DC	0 ... 240 V AC
0830100365	12 ... 60 V DC	12 ... 240 V AC
0830100368	12 ... 60 V DC	12 ... 240 V AC
0830100370	12 ... 60 V DC	12 ... 240 V AC
0830100316	0 ... 60 V DC	0 ... 240 V AC
0830100373	0 ... 60 V DC	0 ... 240 V AC
0830100367	12 ... 60 V DC	12 ... 240 V AC
0830100317	12 ... 60 V DC	12 ... 240 V AC
0830100366	12 ... 60 V DC	12 ... 240 V AC
0830100369	12 ... 60 V DC	12 ... 240 V AC
0830100327	12 ... 60 V DC	12 ... 240 V AC
0830100325	12 ... 60 V DC	12 ... 240 V AC
0830100326	12 ... 60 V DC	12 ... 240 V AC
R412004848	12 ... 60 V DC	12 ... 240 V AC
0830100371	12 ... 42 V DC	12 ... 42 V AC
0830100372	12 ... 42 V DC	12 ... 42 V AC
0830100375	10 ... 30 V DC	10 ... 30 V AC
0830100378	10 ... 30 V DC	-
0830100377	10 ... 30 V DC	10 ... 30 V AC
0830100376	10 ... 30 V DC	10 ... 30 V AC

Part No.	Voltage drop U at I _{max}	DC switching current, max.
0830100315	$R_s \cdot I_{max}$.	0.13 A
0830100365	2,1 V + I*Rs	0.13 A
0830100368	2,1 V + I*Rs	0.3 A
0830100370	2,1 V + I*Rs	0.3 A
0830100316	$R_s \cdot I_{max}$.	0.13 A
0830100373	$R_s \cdot I_{max}$.	0.13 A
0830100367	2,1 V + I*Rs	0.13 A
0830100317	2,1 V + I*Rs	0.12 A
0830100366	2,1 V + I*Rs	0.13 A
0830100369	2,1 V + I*Rs	0.3 A
0830100327	2,1 V + I*Rs	0.3 A
0830100325	2,1 V + I*Rs	0.13 A
0830100326	2,1 V + I*Rs	0.12 A
R412004848	2,1 V + I*Rs	0.13 A
0830100371	I*Rs	0.13 A
0830100372	I*Rs	0.13 A
0830100375	≤ 2,0 V	0.13 A
0830100378	2,1 V + I*Rs	0.12 A
0830100377	≤ 2,0 V	0.13 A
0830100376	≤ 2,0 V	0.13 A

Part No.	AC switching current, max.	Ambient temperature min./max.	Switching capacity
0830100315	0.13 A	-20 ... 80 °C	10 W / 10 VA
0830100365	0.13 A	-20 ... 80 °C	10 W / 10 VA
0830100368	0.5 A	-20 ... 80 °C	10 W / 10 VA
0830100370	0.5 A	-20 ... 80 °C	10 W / 10 VA
0830100316	-	-20 ... 80 °C	10 W / 10 VA
0830100373	-	-20 ... 80 °C	10 W / 10 VA
0830100367	0.13 A	-20 ... 80 °C	10 W / 10 VA
0830100317	0.12 A	-20 ... 120 °C	10 W / 10 VA
0830100366	0.13 A	-20 ... 80 °C	10 W / 10 VA
0830100369	0.5 A	-20 ... 80 °C	10 W / 10 VA
0830100327	0.5 A	-20 ... 80 °C	10 W / 10 VA
0830100325	0.13 A	-20 ... 80 °C	10 W / 10 VA
0830100326	0.12 A	-20 ... 120 °C	10 W / 10 VA
R412004848	0.13 A	-20 ... 80 °C	10 W / 10 VA
0830100371	0.13 A	-20 ... 80 °C	5,5 W / 5,5 VA
0830100372	0.13 A	-20 ... 80 °C	5,5 W / 5,5 VA
0830100375	-	-10 ... 70 °C	-
0830100378	-	-20 ... 120 °C	10 W / 10 VA
0830100377	-	-10 ... 70 °C	-
0830100376	-	-10 ... 70 °C	-

Part No.	Protective resistor for reed	Vibration resistance	Shock resistance
0830100315	27 Ω	-	-

Part No.	Protective resistor for reed	Vibration resistance	Shock resistance
0830100365	27 Ω	30 g (50 - 1000 Hz)	50 g / 11 ms
0830100368	1,3 Ω	30 g (50 - 1000 Hz)	50 g / 11 ms
0830100370	1,3 Ω	30 g (50 - 1000 Hz)	50 g / 11 ms
0830100316	1,3 Ω	-	-
0830100373	100 Ω	-	-
0830100367	27 Ω	30 g (50 - 1000 Hz)	50 g / 11 ms
0830100317	27 Ω	30 g (50 - 1000 Hz)	100 g / 11 ms
0830100366	27 Ω	30 g (50 - 1000 Hz)	50 g / 11 ms
0830100369	1,3 Ω	30 g (50 - 1000 Hz)	50 g / 11 ms
0830100327	1,3 Ω	30 g (50 - 1000 Hz)	50 g / 11 ms
0830100325	27 Ω	30 g (50 - 1000 Hz)	50 g / 11 ms
0830100326	27 Ω	30 g (50 - 1000 Hz)	100 g / 11 ms
R412004848	27 Ω	30 g (50 - 1000 Hz)	50 g / 11 ms
0830100371	27 Ω	30 g (50 - 1000 Hz)	100 g / 11 ms
0830100372	27 Ω	30 g (50 - 1000 Hz)	100 g / 11 ms
0830100375	-	-	-
0830100378	27 Ω	30 g (50 - 1000 Hz)	100 g / 11 ms
0830100377	-	-	-
0830100376	-	-	-

Part No.	Max. switching frequency	Operating current, not switched
0830100315	300 Hz	-
0830100365	-	-
0830100368	-	-
0830100370	-	-
0830100316	300 Hz	-
0830100373	300 Hz	-
0830100367	-	-
0830100317	-	-
0830100366	-	-
0830100369	-	-
0830100327	-	-
0830100325	-	-
0830100326	-	-
R412004848	-	-
0830100371	-	-
0830100372	-	-
0830100375	2000 Hz	10 mA
0830100378	-	-
0830100377	2000 Hz	10 mA
0830100376	2000 Hz	10 mA

Part No.	Operating current, switched	Material Housing	LED status display
0830100315	-	Polyamide	-
0830100365	-	Polyamide	Yellow

Part No.	Operating current, switched	Material Housing	LED status display
0830100368	-	Polyamide	Yellow
0830100370	-	Polyamide	Yellow
0830100316	-	Polyamide	-
0830100373	-	Polyamide	-
0830100367	-	Polyamide	Yellow
0830100317	-	Polyamide	-
0830100366	-	Polyamide	Yellow
0830100369	-	Polyamide	Yellow
0830100327	-	Polyamide	Yellow
0830100325	-	Polyamide	Yellow
0830100326	-	Polyamide	-
R412004848	-	epoxy resin	Yellow
0830100371	-	Polyamide	Yellow
0830100372	-	Polyamide	Yellow
0830100375	15 mA	Polyamide	Yellow
0830100378	-	Polyamide	-
0830100377	15 mA	Polyamide	Yellow
0830100376	15 mA	Polyamide	Yellow

Part No.	Version	
0830100315	Protected against polarity reversal	1)
0830100365	Protected against polarity reversal	1)
0830100368	Protected against polarity reversal	1)
0830100370	Protected against polarity reversal	1)
0830100316	Protected against polarity reversal	1)
0830100373	Protected against polarity reversal	1)
0830100367	Protected against polarity reversal	1)
0830100317	Protected against polarity reversal	1)
0830100366	Protected against polarity reversal	1)
0830100369	Protected against polarity reversal	1)
0830100327	Protected against polarity reversal	1)
0830100325	Protected against polarity reversal	1)
0830100326	Protected against polarity reversal	1)
R412004848	Protected against polarity reversal	1)
0830100371	Protected against polarity reversal	1)
0830100372	Protected against polarity reversal	1)
0830100375	short circuit resistant Protected against polarity reversal	2)
0830100378	Protected against polarity reversal	2)
0830100377	short circuit resistant Protected against polarity reversal	2)
0830100376	short circuit resistant Protected against polarity reversal	2)

1) without wire end ferrule, tin-plated, 2-pin

2) without wire end ferrule, tin-plated, 3-pin

Technical information

If reed sensors are used, we recommend using a short-circuit protective device (SCPD).

Technical information

Material

Housing	Polyamide epoxy resin
Cable sheath	Polyvinyl chloride Polyurethane Thermoplastic elastomer

Dimensions

Dimensions

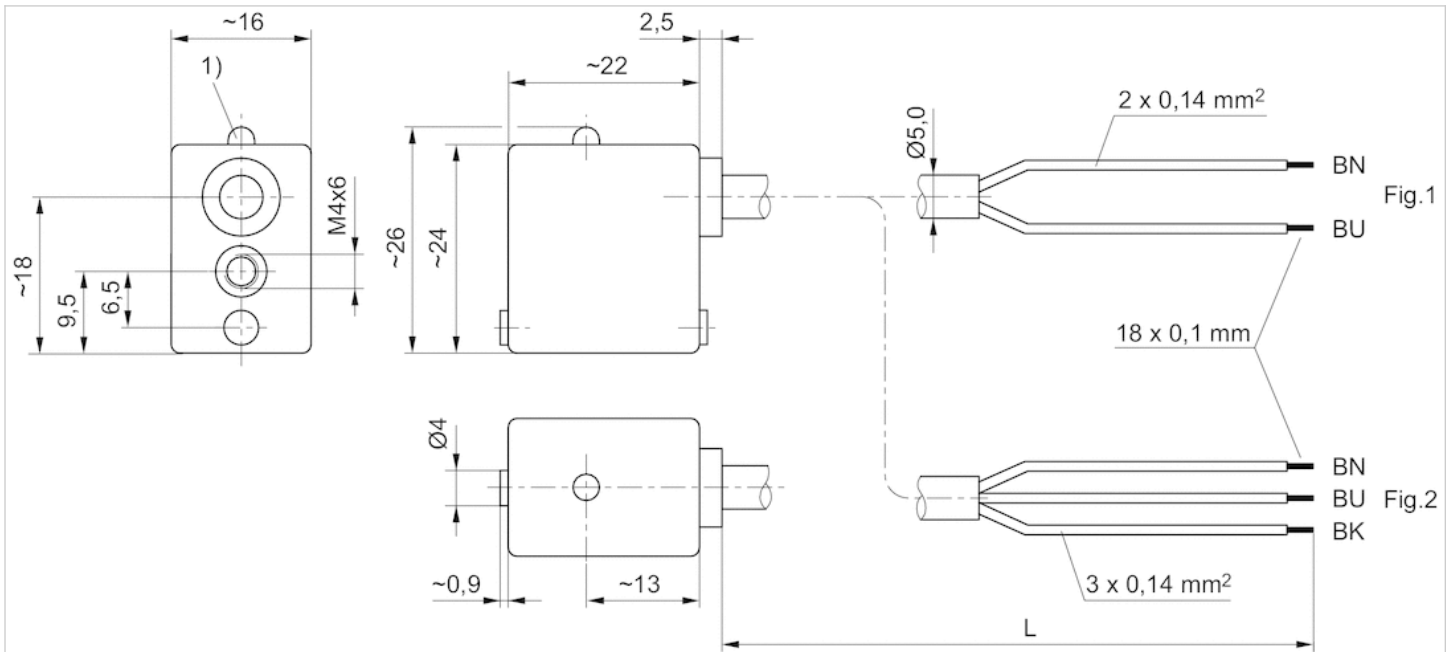

1) LED

L = cable length

BN = brown, BK = black, BU = blue











Sensor, Series SN2

- Plug, M8, 2-pin Plug, M8, 3-pin Plug, M8, 4-pin
- Reed 2-Wire Reed 3-Wire Reed 3-Wire, with pulse stretching Reed 4-Wire electronic PNP
- With stretched impulse
- With stretched impulse
- Reed electronic PNP
- Indirect mounting for series TRB, PRA, ITS, MNI, CSL-RD, ICM, RPC, TRR, FLT, CVI



Ambient temperature min./max.	See table below
Protection class	IP67
Switching point precision	±0,1 mT
Nominal current, actuated state	15 mA
Quiescent current (without load)	10 mA
Min./max. DC operating voltage	See table below
Min./max. AC operating voltage	See table below
LED status display	See table below

Technical data

Part No.		Type of contact	Min./max. DC operating voltage
0830100465		Reed	12 ... 36 V DC
0830100468		Reed	12 ... 36 V DC
R412004299		Reed	12 ... 36 V DC
0830100466		Reed	12 ... 36 V DC
0830100469		Reed	12 ... 36 V DC
R412004820		Reed	12 ... 36 V DC
0830100472		Reed	12 ... 36 V DC
0830100467		Reed	12 ... 36 V DC
0830100480		electronic PNP	10 ... 30 V DC
R412004800		electronic PNP	10 ... 30 V DC

Part No.	Min./max. AC operating voltage	Voltage drop U at I _{max}
0830100465	12 ... 30 V AC	2,1 V + I*Rs
0830100468	12 ... 30 V AC	2,1 V + I*Rs
R412004299	12 ... 30 V AC	2,1 V + I*Rs
0830100466	12 ... 30 V AC	2,1 V + I*Rs
0830100469	12 ... 30 V AC	≤ 0,5 V
R412004820	12 ... 30 V AC	I*Rs
0830100472	12 ... 30 V AC	≤ 1,5 V
0830100467	12 ... 30 V AC	≤ 3,5 V
0830100480	12 ... 30 V AC	≤ 2,0 V
R412004800	-	≤ 2,0 V

Part No.	DC switching current, max.	AC switching current, max.
0830100465	0.13 A	0.13 A
0830100468	0.3 A	0.5 A
R412004299	0.13 A	0.13 A
0830100466	0.13 A	0.13 A
0830100469	0.13 A	0.13 A
R412004820	0.13 A	0.13 A
0830100472	0.2 A	0.13 A
0830100467	0.13 A	0.13 A
0830100480	0.13 A	-
R412004800	0.13 A	-

Part No.	Function	Ambient temperature min./max.
0830100465	Reed 2-Wire	-20 ... 80 °C
0830100468	Reed 2-Wire	-20 ... 80 °C
R412004299	Reed 3-Wire	-20 ... 80 °C
0830100466	Reed 3-Wire	-20 ... 80 °C
0830100469	Reed 3-Wire	-20 ... 80 °C

Part No.	Function	Ambient temperature min./max.
R412004820	Reed 3-Wire	-20 ... 80 °C
0830100472	Reed 3-Wire, with pulse stretching	-20 ... 70 °C
0830100467	Reed 4-Wire	-20 ... 80 °C
0830100480	electronic PNP	-10 ... 70 °C
R412004800	electronic PNP	-10 ... 70 °C

Part No.	Switching capacity	Protective resistor for reed	Vibration resistance
0830100465	10 W / 10 VA	27 Ω	30 g (50 - 2000 Hz)
0830100468	10 W / 10 VA	1,3 Ω	30 g (50 - 2000 Hz)
R412004299	10 W / 10 VA	27 Ω	30 g (50 - 2000 Hz)
0830100466	10 W / 10 VA	100 Ω	30 g (50 - 2000 Hz)
0830100469	5,5 W / 5,5 VA	27 Ω	30 g (50 - 1000 Hz)
R412004820	10 W / 10 VA	27 Ω	30 g (50 - 2000 Hz)
0830100472	5 W / 5 VA	-	35 g (50 - 2000 Hz)
0830100467	10 W / 10 VA	27 Ω	35 g (50 - 2000 Hz)
0830100480	-	-	-
R412004800	-	-	-

Part No.	Shock resistance	Max. switching frequency	Operating current, not switched
0830100465	100 g / 11 ms	-	-
0830100468	100 g / 11 ms	-	-
R412004299	100 g / 11 ms	-	-
0830100466	100 g / 11 ms	-	-
0830100469	100 g / 11 ms	-	-
R412004820	100 g / 11 ms	-	-
0830100472	50 g / 11 ms	-	-
0830100467	50 g / 11 ms	-	-
0830100480	-	2000 Hz	10 mA
R412004800	-	2000 Hz	10 mA

Part No.	Operating current, switched	Material Housing	LED status display
0830100465	-	Polyamide	Yellow
0830100468	-	Polyamide	Yellow
R412004299	-	Polyamide	Yellow
0830100466	-	Polyamide	Yellow
0830100469	-	Polyamide	Yellow
R412004820	-	epoxy resin	Yellow
0830100472	-	-	Red
0830100467	-	epoxy resin	Red
0830100480	15 mA	Polyamide	Yellow
R412004800	15 mA	epoxy resin	Yellow

Part No.	Version
0830100465	Protected against polarity reversal
0830100468	Protected against polarity reversal
R412004299	Protected against polarity reversal
0830100466	Protected against polarity reversal
0830100469	Protected against polarity reversal
R412004820	Protected against polarity reversal
0830100472	Protected against polarity reversal
0830100467	Protected against polarity reversal
0830100480	short circuit resistant Protected against polarity reversal
R412004800	short circuit resistant Protected against polarity reversal

Part No.	Switch signal	Fig.	
0830100465	-	Fig. 1	1)
0830100468	-	Fig. 1	1)
R412004299	-	Fig. 1	2)
0830100466	-	Fig. 1	1)
0830100469	-	Fig. 1	2)
R412004820	-	Fig. 1	2)
0830100472	With stretched impulse	Fig. 1	2)
0830100467	-	Fig. 2	3)
0830100480	-	Fig. 1	2)
R412004800	-	Fig. 1	2)

- 1) Plug M8, 2-pin
- 2) Plug M8, 3-pin
- 3) Plug M8, 4-pin

Technical information

If reed sensors are used, we recommend using a short-circuit protective device (SCPD).

Technical information

Material	
Housing	Polyamide epoxy resin

Dimensions

Fig. 1

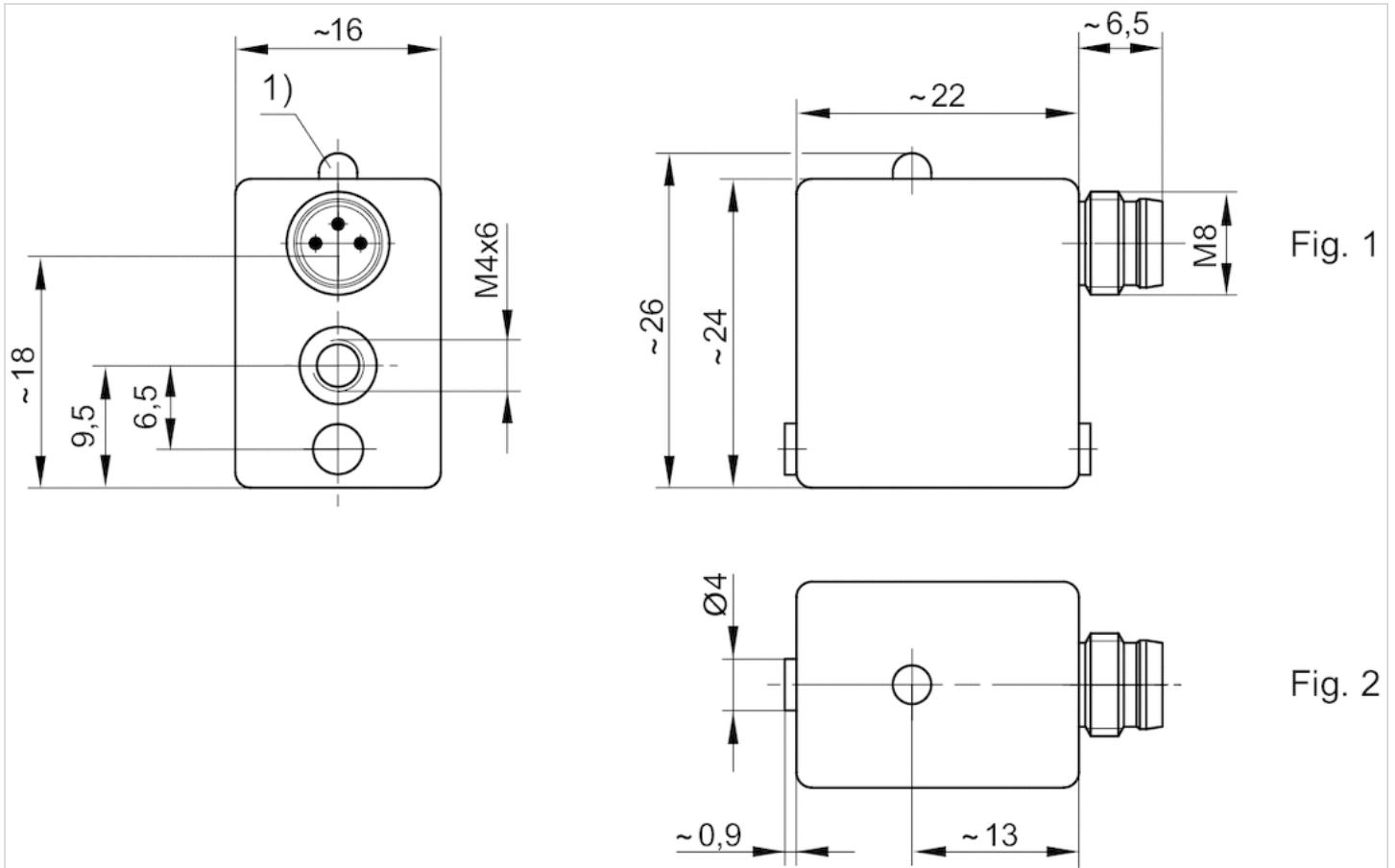

1) LED

M8: combination plug can be combined with valve plug connectors Ø6.5 mm and M8.
 Pin assignments: 1 = (+), 3 = (-), 4 = (OUT), EN 60947-5-2:1998

Fig. 2

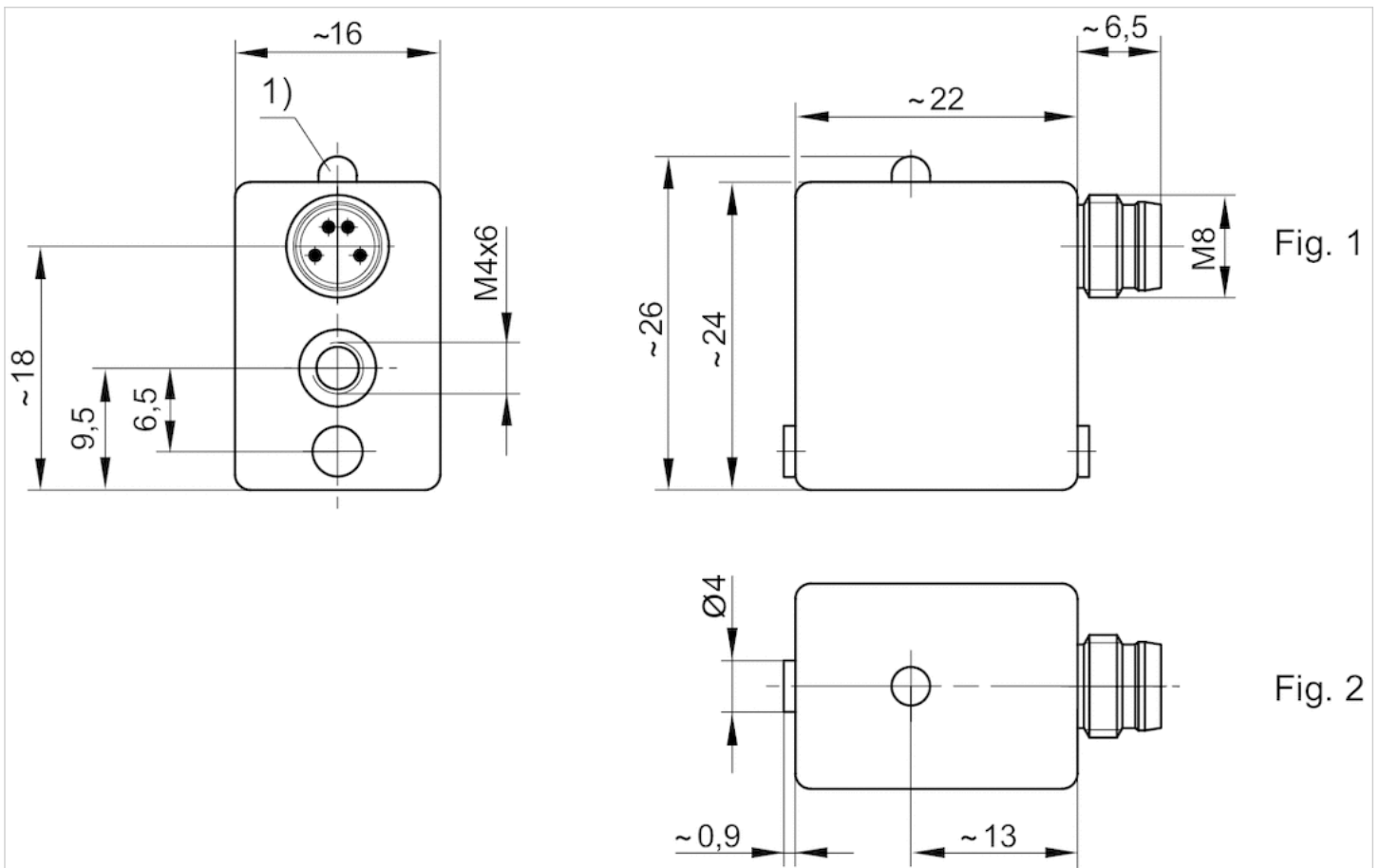

1) LED

M8: combination plug can be combined with valve plug connectors Ø6.5 mm and M8.

Pin assignments

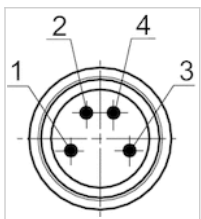

Pin	1	3	4
Allocation	(+)	(-)	(OUT)

EN 60947-5-2:1998

Pin assignments

Pin assignments

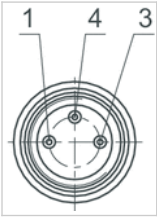

Pin	1	3	4
Allocation	(+)	(-)	(OUT)

Round plug connector, Series CON-RD

- Socket M8x1 3-pin A-coded straight 180°
- open cable ends
- with cable
- UL (Underwriters Laboratories)
- unshielded



Ambient temperature min./max.	-25 ... 85 °C
Operational voltage	48 V AC/DC
Protection class	IP67
Wire cross-section	0.24 mm ²
Weight	See table below

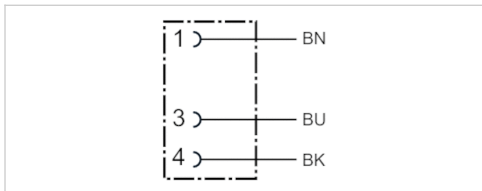

Technical data

Part No.	Max. current	Number of wires	Cable-Ø	Cable length	Certification	Weight
1834484166	4 A	3	4.5 mm	3 m	UL (Underwriters Laboratories)	0.087 kg
1834484168	4 A	3	4.5 mm	5 m	UL (Underwriters Laboratories)	0.141 kg
1834484247	4 A	3	4.5 mm	10 m	UL (Underwriters Laboratories)	0.277 kg

Technical information

The specified protection class is only valid in assembled and tested state.

Technical information

Material	
Housing	Polyurethane
Cable sheath	Polyurethane

Dimensions

Dimensions

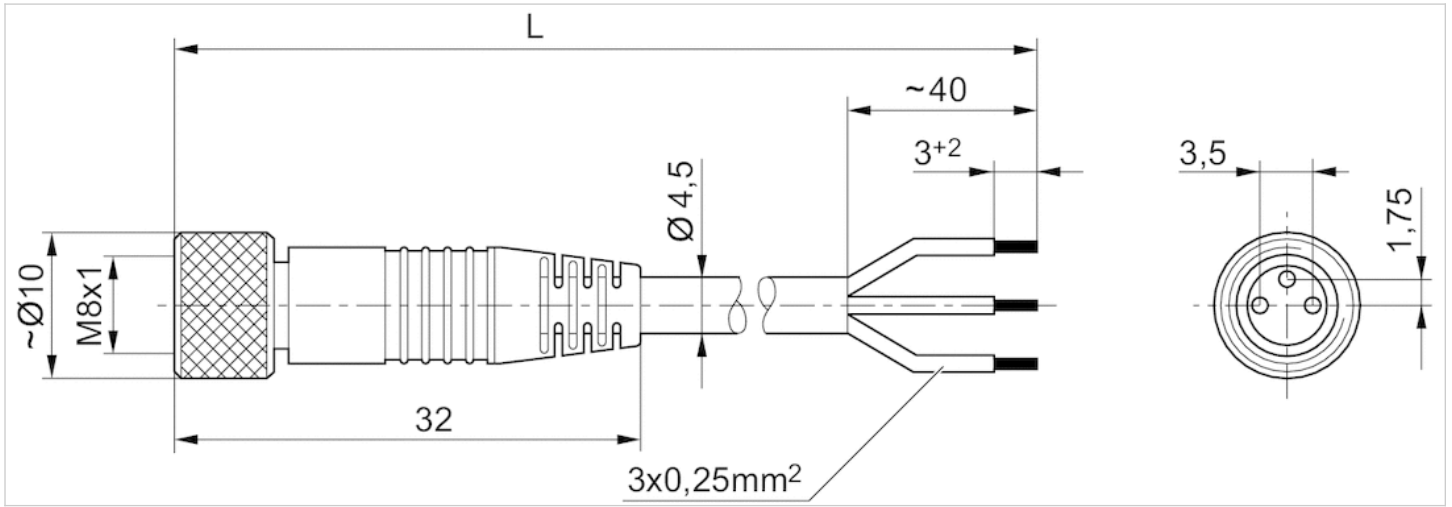

L = length

Pin assignments

Pin assignment, socket

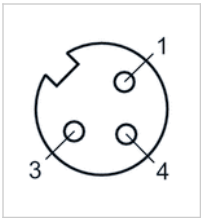

- (1) BN=brown
- (3) BU=blue
- (4) BK=black

Sensor mounting, Series CB1

- for series SN1, SN2
- to mount on cylinder MNI



Weight

See table below

Technical data

Part No.	Cylinders Ø		for series	Weight
	min.	max.		
1827020065	10 mm	10 mm	SN1, SN2	0.016 kg
1827020066	12 mm	12 mm	SN1, SN2	0.018 kg
1827020067	16 mm	16 mm	SN1, SN2	0.02 kg
1827020068	20 mm	20 mm	SN1, SN2	0.021 kg
1827020069	25 mm	25 mm	SN1, SN2	0.025 kg

Technical information

Material	
	Aluminum

Dimensions

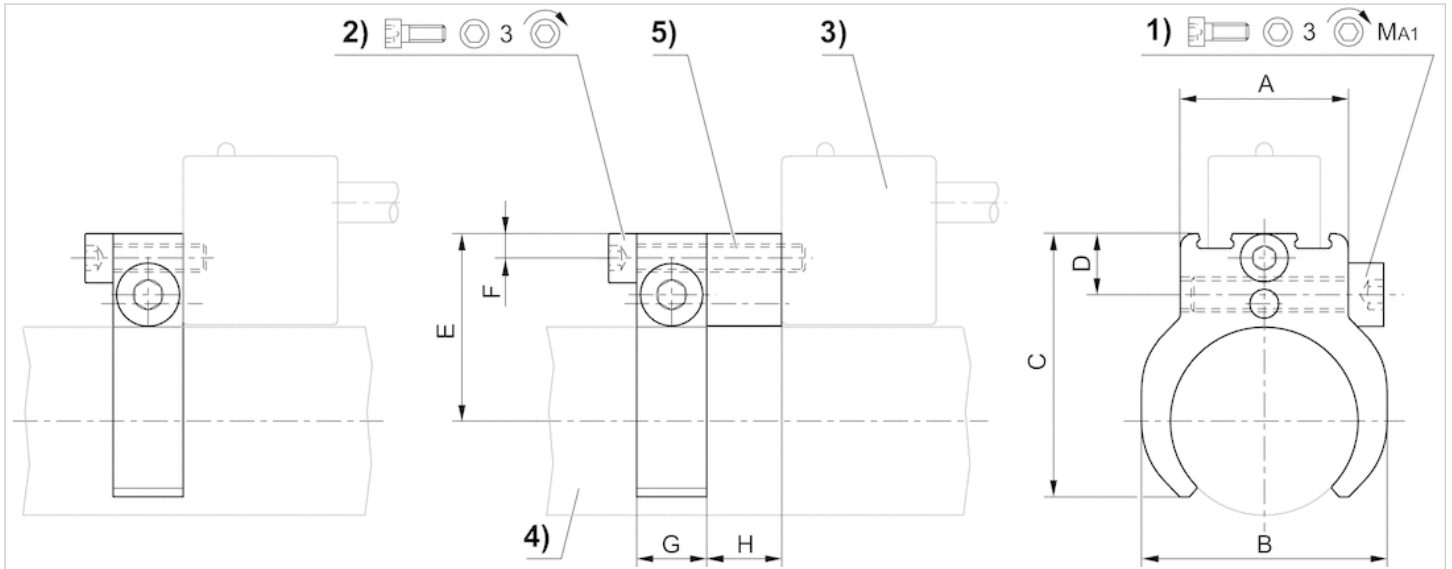

1) Clamping screw 2) Mounting screw for sensor 3) Sensor 4) Cylinder profile 5) Insert (on request)

Dimensions

Part No.	Cylinders Ø mm	A	B	C	D	E	F	G	H	1)	MA1 [Nm]
1827020065	10 mm	16	16	23.5	8.2	18.7	3.5	10	10.7	M4x14	1 +0,3
1827020066	12 mm	16	20	25.5	8.2	19.9	3.5	10	10.7	M4x14	1 +0,3
1827020067	16 mm	20	24	29.7	8.7	21.9	3.5	10	10.7	M4x25	1 +0,3
1827020068	20 mm	20	28	33	8.7	24.1	3.5	10	10.7	M4x25	1 +0,3
1827020069	25 mm	24	35	37.5	8.7	26.6	3.5	10	10.7	M4x25	1 +0,3

Sensor mounting, Series CB1

- for series ST6, SN2, SN6, SN1, SM6, SM6-AL
- to mount on cylinder C12P, ITS



Weight

See table below

Technical data

Part No.	Cylinders Ø		for series	Weight
	min.	max.		
R412017979	160 mm	200 mm	ST6, SN2, SN6, SN1, SM6, SM6-AL	0.058 kg
R412017980	250 mm	320 mm	ST6, SN2, SN6, SN1, SM6, SM6-AL	0.073 kg

Scope of delivery: Incl. mounting screws

Technical information

Material	
	Aluminum

Dimensions

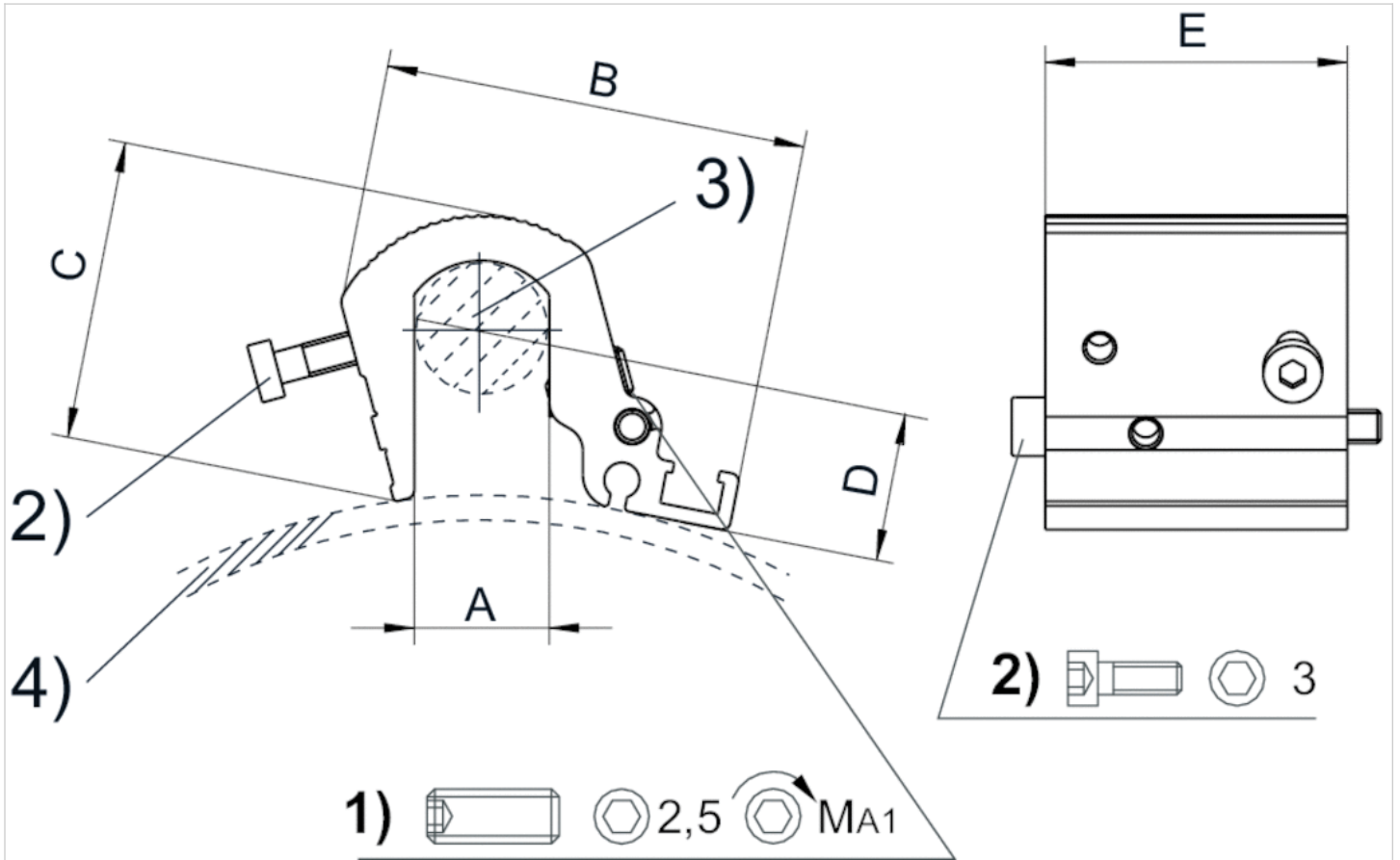

1) Clamping threaded pin 2) Mounting screws for sensor 3) Tie rod 4) Cylinder profile

Dimensions

Part No.	Cylinders Ø	A	B	C	D	E	MA1 [Nm]
R412017979	200 mm	16	51	36	6.8	36	2
R412017980	320 mm	24	56	44.5	6.8	36	2

Scope of delivery: Incl. mounting screws

Sensor mounting, Series CB1

- for series ST6, SM6, SN1, SN2

- to mount on cylinder TRB, C12P, CVI, 523



Weight

0.031 kg

Technical data

Part No.	Cylinders Ø		for series
	min.	max.	
1827020292	125 mm	125 mm	ST6, SM6, SN1, SN2

Technical information

Material	
	Aluminum

Dimensions

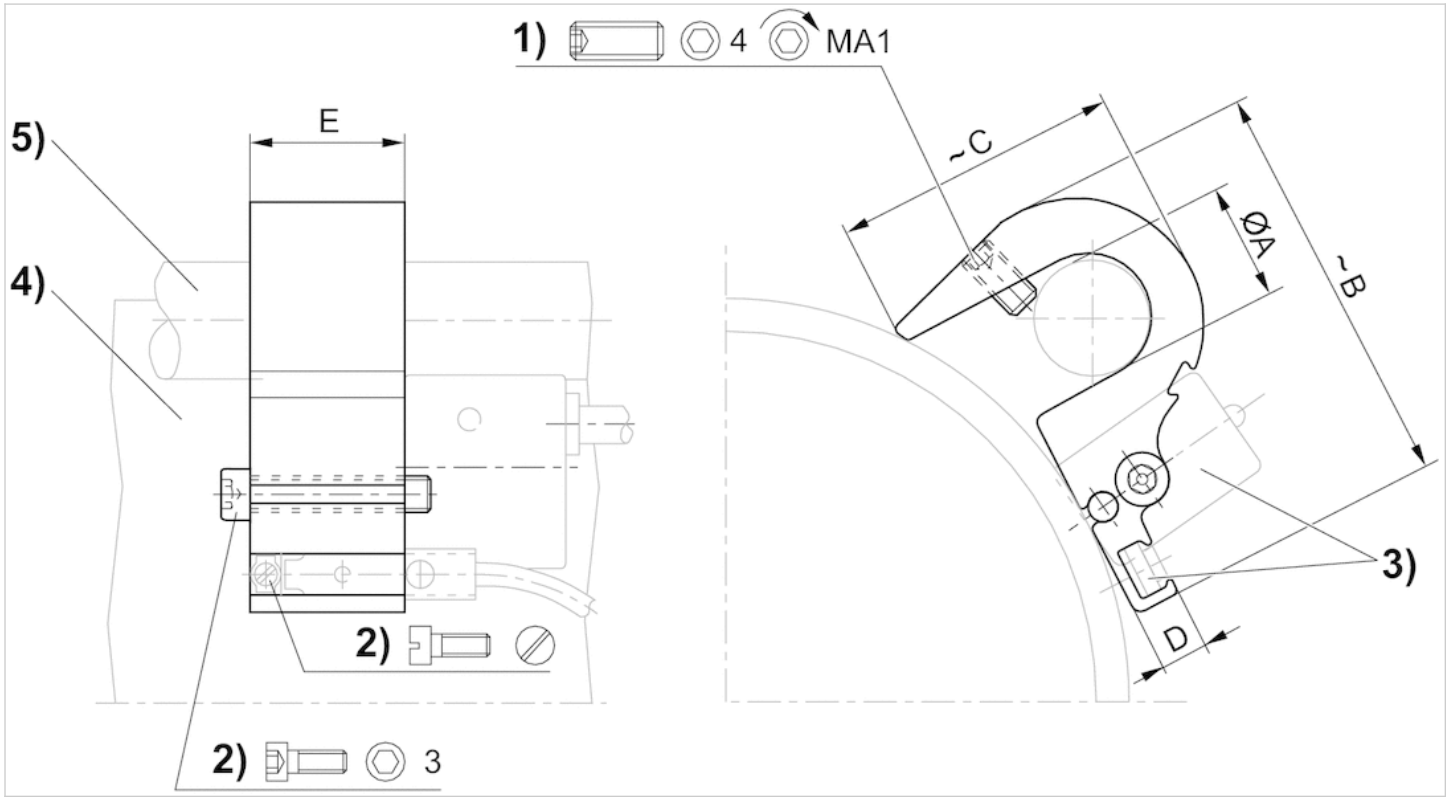

1) Clamping threaded pin 2) Mounting screw for sensor 3) Sensor 4) Cylinder profile 5) Tie rod

Dimensions

Part No.	Ø A	B	C	D	E	1)	MA1 [Nm]
1827020292	12	45	29	6.5	21	M5x10	2

Sensor mounting, Series CB1

- for series SN1, SN2
- to mount on cylinder PRA



Weight

0.006 kg

Technical data

Part No.	for series
1827020084	SN1, SN2

Technical information

Material
Aluminum

Dimensions

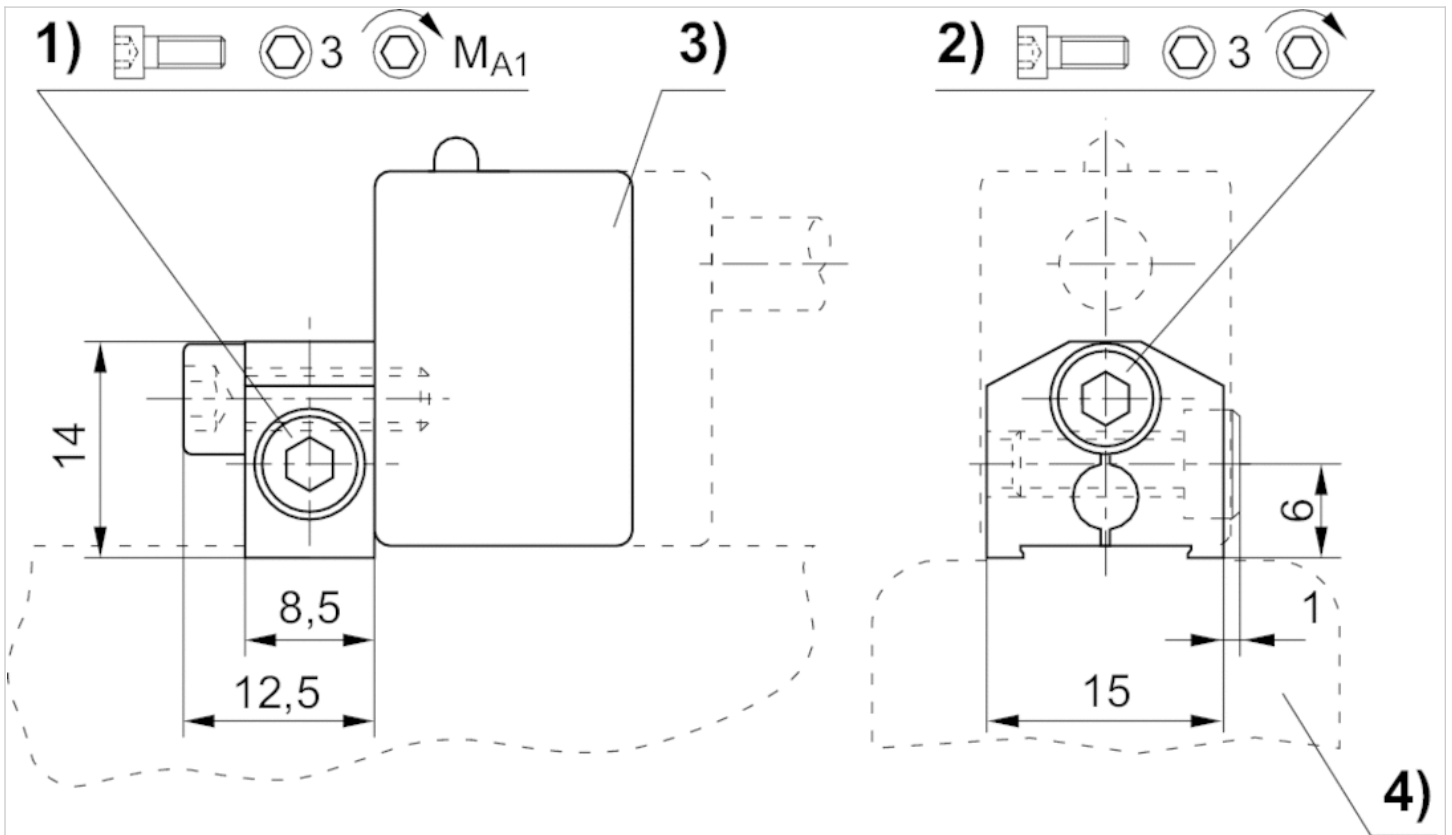

1) Clamping screw 2) Mounting screw for sensor 3) Sensor 4) Cylinder profile

Dimensions

Part No.	1)	MA1 [Nm]
1827020084	M4x12	2

Sensor mounting, Series CB1

- for series SN1, SN2
- to mount on cylinder TRB, TRR



Weight

See table below

Technical data

Part No.	Cylinders Ø		for series	Weight
	min.	max.		
1827020081	32 mm	40 mm	SN1, SN2	0.015 kg
1827020082	50 mm	63 mm	SN1, SN2	0.013 kg
1827020083	80 mm	100 mm	SN1, SN2	0.018 kg

Technical information

Material	
	Aluminum

Dimensions

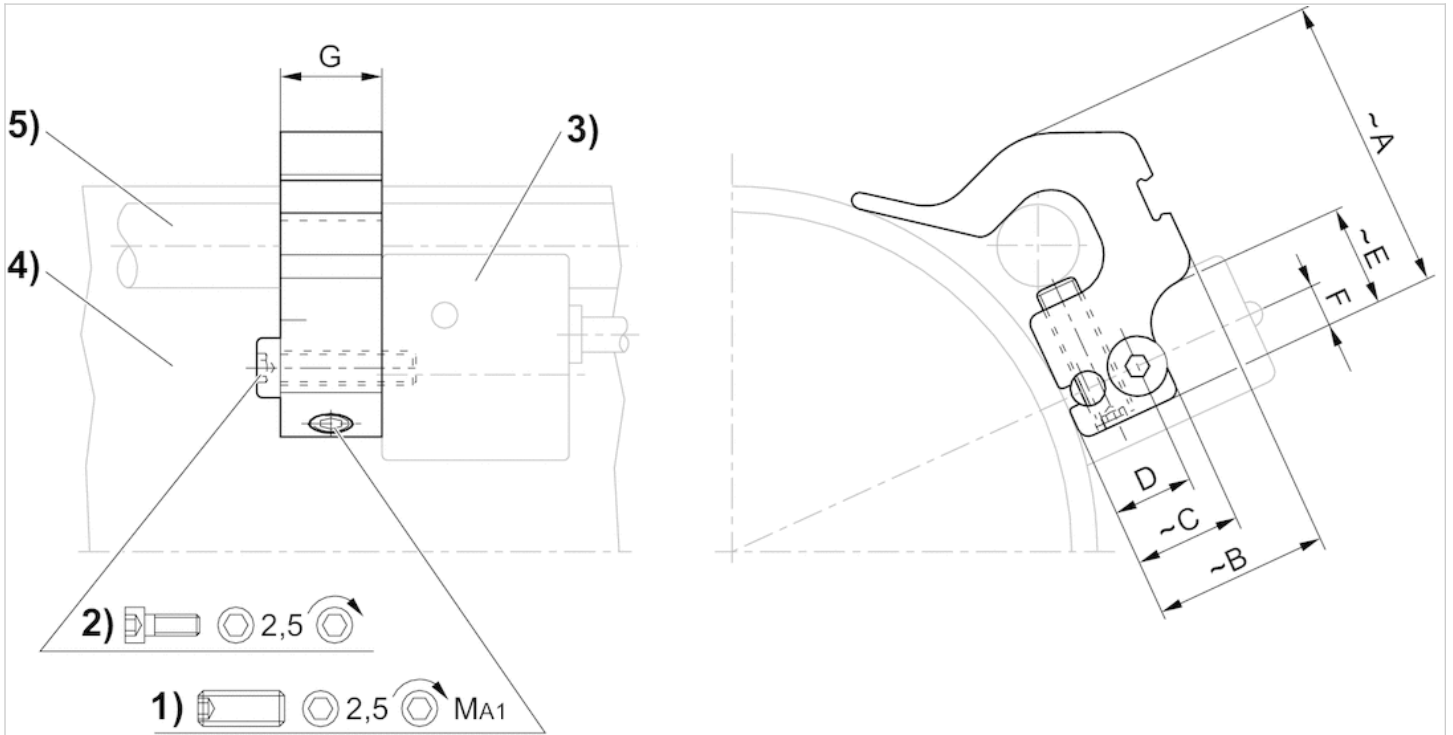

1) Clamping threaded pin 2) Mounting screw for sensor 3) Sensor 4) Cylinder profile 5) Tie rod

Dimensions

Part No.	Cylinders Ø mm	A	B	C	D	E	F	G	1)	MA1 [Nm]
1827020081	32 mm	25.3	12.5	12.5	9.5	-	5	16	M5x16	1 +0,3
1827020082	50 mm	28.7	15.6	12.5	9.5	12	5	12	M5x16	1 +0,3
1827020083	80 mm	33.8	23	12.5	9.5	12	5	12	M5x16	1 +0,3

Round plug connector, Series CON-RD

- Socket M8x1 3-pin A-coded straight 180°
- Plug A-coded straight 180°
- with cable
- unshielded



Protection class
Weight

IP68
See table below

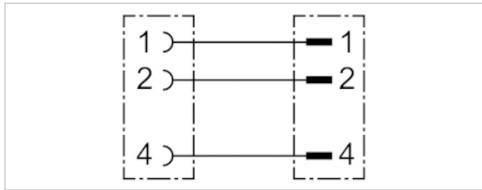

Technical data

Part No.	Number of wires	Cable-Ø	Cable length	Weight
8946203702	3	4.5 mm	1 m	0.038 kg
8946203712	3	4.5 mm	2 m	0.067 kg
8946203722	3	4.5 mm	5 m	0.148 kg

Technical information

The specified protection class is only valid in assembled and tested state.

Technical information

Material	
Cable sheath	Polyvinyl chloride

Dimensions

Dimensions

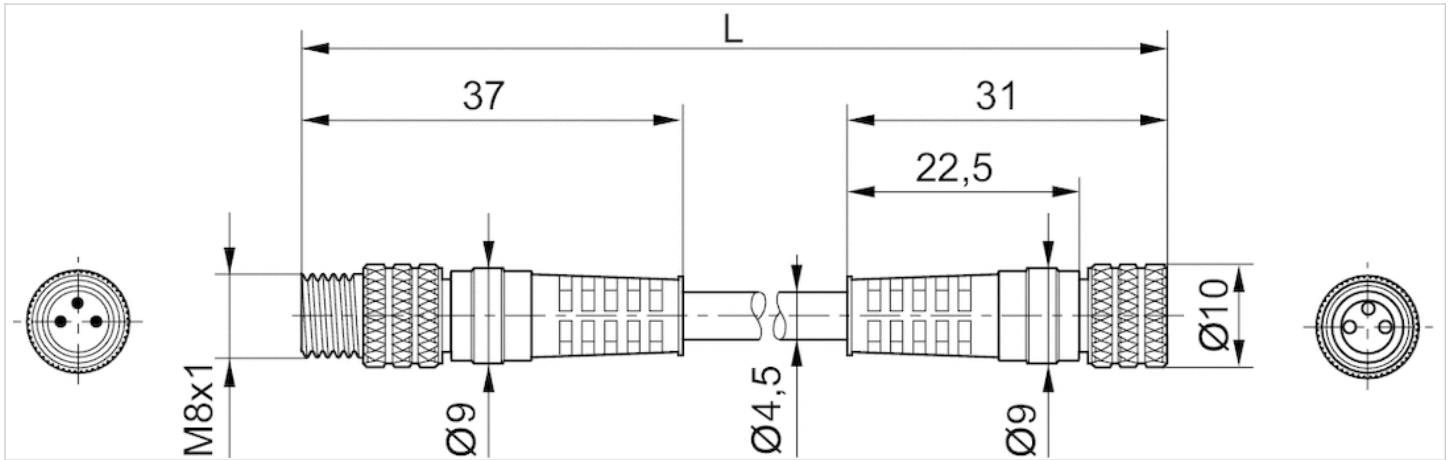

L = length

Pin assignments

Pin assignment, socket

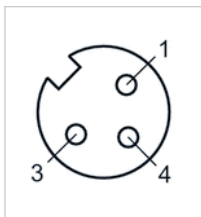

Plug pin assignment

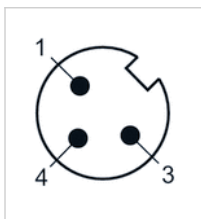

Round plug connector, Series CON-RD

- Socket M8x1 3-pin A-coded angled 90°
- open cable ends
- with cable
- unshielded



Ambient temperature min./max.	-40 ... 85 °C
Operational voltage	48 V AC/DC
Protection class	IP67
Wire cross-section	0.24 mm ²
Weight	See table below

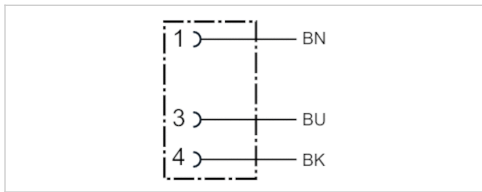

Technical data

Part No.	Max. current	Number of wires	Cable-Ø	Cable length	Weight
1834484167	4 A	3	4.5 mm	3 m	0.087 kg
1834484169	4 A	3	4.5 mm	5 m	0.139 kg
1834484248	4 A	3	4.5 mm	10 m	0.279 kg

Technical information

The specified protection class is only valid in assembled and tested state.

Technical information

Material	
Housing	Polyurethane
Cable sheath	Polyurethane

Dimensions

Dimensions

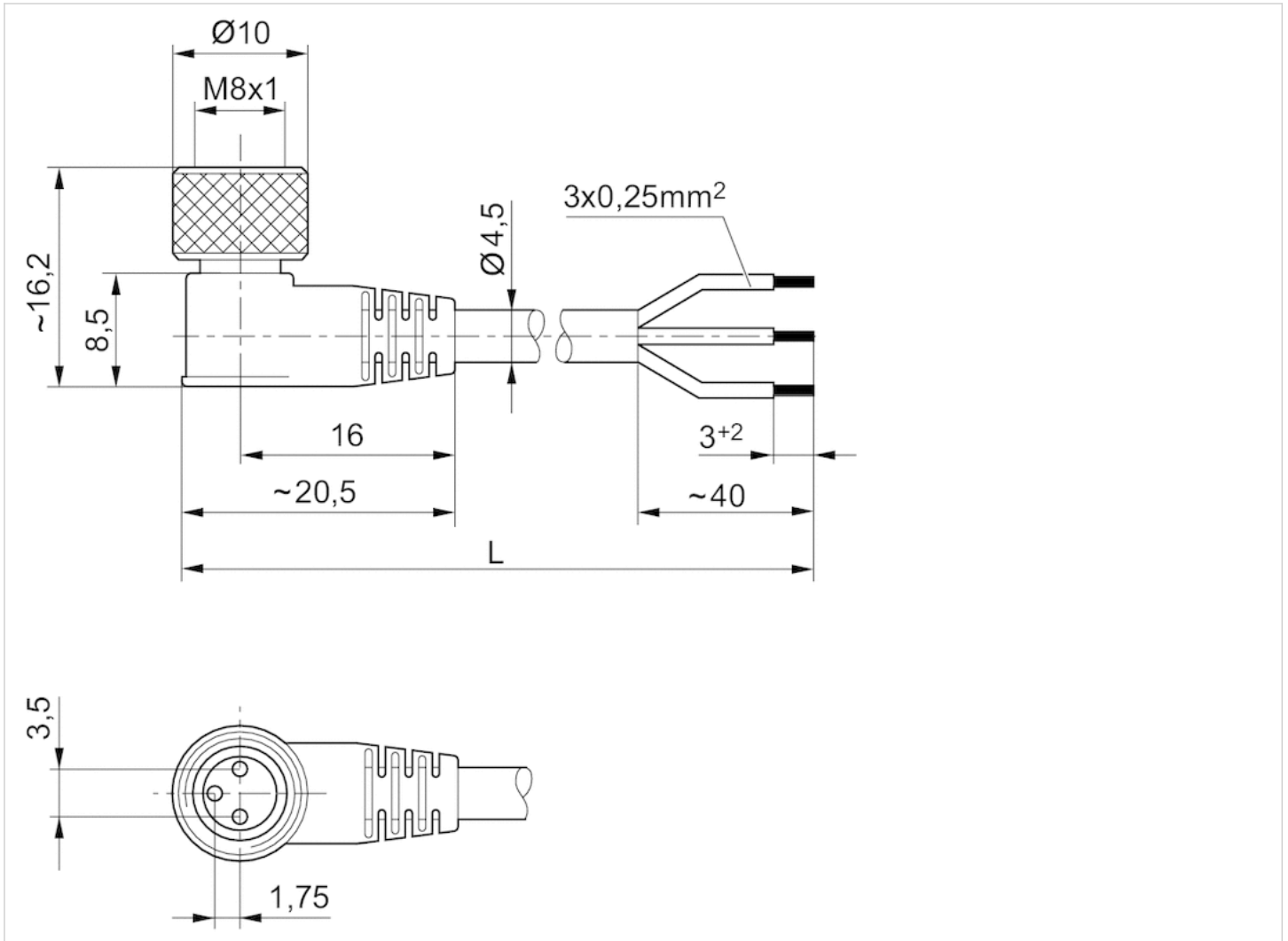

L = length

Pin assignments

Pin assignment, socket

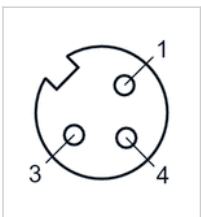

- (1) BN=brown
- (3) BU=blue
- (4) BK=black

Efficient pneumatic solutions, our program: cylinders and drives, valves and valve systems, air supply management



Visit us: Emerson.com/Aventics

Your local contact: Emerson.com/contactus



Emerson.com



Facebook.com/EmersonAutomationSolutions



LinkedIn.com/company/Emerson-Automation-Solutions



Twitter.com/EMR_Automation

An example configuration is depicted on the title page. The delivered product may thus vary from that in the illustration. Subject to change. This Document, as well as the data, specifications and other information set forth in it, are the exclusive property of AVENTICS GmbH. It may not be reproduced or given to third parties without its consent. Only use the AVENTICS products shown in industrial applications. Read the product documentation completely and carefully before using the product. Observe the applicable regulations and laws of the respective country. When integrating the product into applications, note the system manufacturer's specifications for safe use of the product. The data specified only serve to describe the product. No statements concerning a certain condition or suitability for a certain application can be derived from our information. The information given does not release the user from the obligation of own judgment and verification. It must be remembered that the products are subject to a natural process of wear and aging.

The Emerson logo is a trademark and service mark of Emerson Electric Co. Brand logotype are registered trademarks of one of the Emerson family of companies. All other marks are the property of their respective owners. © 2017 Emerson Electric Co. All rights reserved.
2019-03



CONSIDER IT SOLVED™



青岛秉诚自动化设备有限公司
地址：中国·青岛市重庆南路99号海尔云街甲3号楼7F

服务热线：4006-918-365
网址：<http://www.asco.store>

传真：(86-532)585-10-365
Email：sales@bechinas.com