

Features

- Single Pole Double Throw (SPDT)
- Palladium silver contacts
- 5/8" dia. 316L SS Enclosure
- 1/2" NPT Conduit Entry
- Class I, Div. 2; Class II, Div. 2; Class III certified
- Stainless Steel Sensing Face

Technical Specifications

Nominal sensing distance	2.5 mm (0.100 in)
Hysteresis	0.2 mm (0.008 in)
Actuating element	Ferrous metal or magnet (N)
Maximum Operating AC Voltage	120 VAC
Maximum Load Current	250mA
Minimum Load Current	10mA
Approximate Voltage drop	5V
Operating DC Voltage	10-30 VDC
Max initial contact resistance	0.5 Ohm
Max switching frequency	10 Hz
Operating temp range	-40°C to 60°C (-40°F to 140°F)
Enclosure material	316L stainless steel
Ingression protection	IP66/IP68
Vibration resistance	10 - 55 Hz, 1.5-mm double amplitude
Pressure Rating (Sensing Face)	140 Bar (2000 PSI)
Shock resistance	1000m/s ²



Model 7L Dimensions

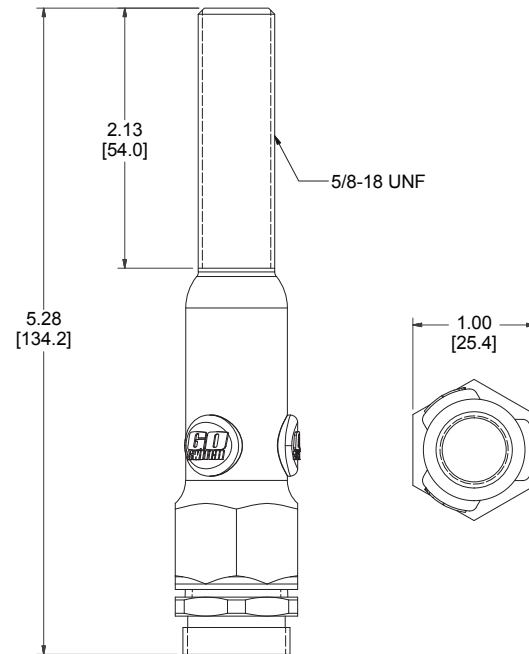

Sensing Range:

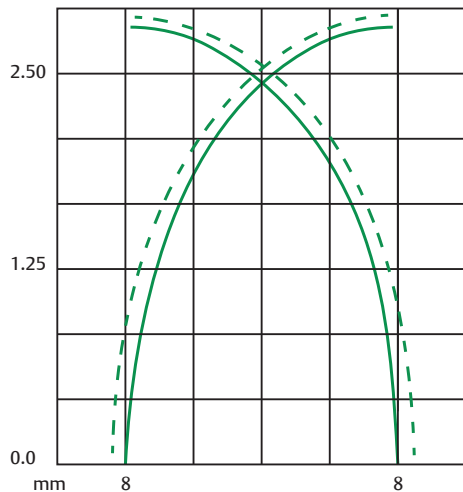

Model 7L

TopWorx™ GO™ Switch - Proximity Sensor

Model 7L Wiring

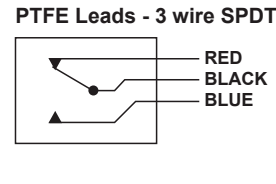
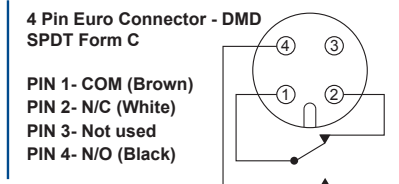
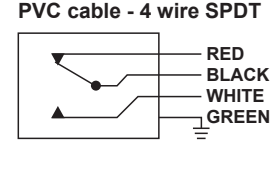
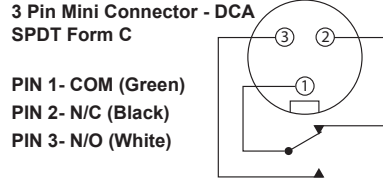
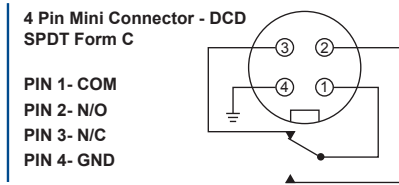

How to Order

Model	Contact Form	Sensing Range	Outlet Position	Enclosure Material	Area Classification	Wiring Options
7LG Green LED Indication 5/8" - 18 mounting thread 1/2" NPT conduit entry	1- SPDT	3- End Sensing 2.5mm (0.100")	5- Bottom of Enclosure	6- 316L Stainless Steel	8 - cULus General Purpose E - cULus Cl I, Div 2, Grps A-D; Cl II, Div 2, Grps E-G; Cl III (Wiring must be A or B) (Lead seal req'd within 18")	Lead Wires—18 Gauge PVC Insulated A2 3' A3 6' A4 12' A5 25' A6 50' A7 100' A8 250' Cable—18 Gauge PVC Insulated B2 3' B3 6' B4 12' B5 25' B6 50' B7 100' B8 250' Mini QDC DCA 3 pin DCD 4 pin Euro M12 QDC DMD 4 pin
7LR Red LED Indication 5/8" - 18 mounting thread 1/2" NPT conduit entry						
7LY Dual LED Indication 5/8" - 18 mounting thread 1/2" NPT conduit entry						
—	— 1	3	5	6	—	—