

numatics®

Actuator Sensors

Sensors and Sensor Brackets

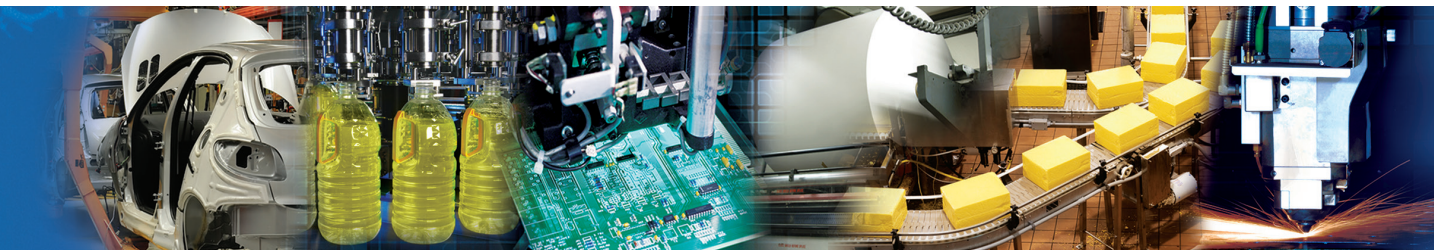

www.numatics.com

EMERSON
Industrial Automation

 **BCAE**
Industrial Automation

青岛秉诚自动化设备有限公司
地址：中国·青岛市重庆南路99号海尔云街甲3号楼7F

服务热线：4006-918-365
网址：<http://www.asco.store>

传真：(86-532)585-10-365
Email：sales@bechinas.com

NUMATICS®

Numatics, Inc. is a leading manufacturer of pneumatic products and motion control products. Our broad spectrum of standard, custom developed products and application components have made a significant impact on pneumatic innovation as well as pneumatic and motion control technology. Our company has an extensive history of generating innovative concepts and technological breakthroughs. Many of today's standard features in pneumatic technology were industry firsts from Numatics. We continue our innovative approach to product development by developing electric motion control solutions and enhancing our embedded Fieldbus and I/O products to continually meet and solve our customer's application requirements.



Today Numatics is proud to be a part of the Industrial Automation Division of Emerson Electric Co.

Emerson (NYSE:EMR), based in St. Louis, Missouri (USA), is a global leader in bringing technology and engineering together to provide innovative solutions for customers in industrial, commercial, and consumer markets through its network power, process management, industrial automation, climate technologies, and appliance and tools businesses. For more information, visit www.Emerson.com.



EMERSON™
Industrial Automation



Numatics Express Shipping Program guarantees† product shipment in two, three or five business days. Unlike most traditional quick ship programs, the Numatics Express Shipping Program includes the most comprehensive offering in the industry. This program encompasses the range and options that you require!

Numatics is committed to offering you the highest level of customer service, quality and performance.

2DAY

Numatics Express 2Day shipping program guarantees† product shipment in two business days. The program includes the most popular valve, air preparation and actuator products and includes applicable switches and mounting accessories.

Numatics guarantees† to ship any order received before 3 pm EST for up to 10 2Day products* in two business days.

3DAY

Numatics Express shipping program offers a 3Day shipping program that guarantees† product shipment of a fully assembled and tested valve manifold in 3 business days. The program includes the most popular manifold configurations of the 2000 and Mark series valves:

- Sub D, Terminal Strip and Fieldbus Electronic Options
- Can be configured for DIN Rail Mounting and Muffled Exhaust
- Shipped complete and 100% tested

The 3Day Express shipping program enables you to create a 2 to 8 station manifold assembly complete with any combination of valves, regulators, and blank stations that can be configured from the valve model charts in this catalog.

Numatics guarantees† to ship any order received before 3 pm EST for up to 5 manifold assemblies configured from this catalog in three business days or Numatics pays the shipping cost.

5DAY

We are pleased to expand Numatics Express to include a broad range of products in a 5Day shipping program. Numatics guarantees† to ship up to 10 of any 5Day product** for orders received before 3 pm EST in 5 business days or Numatics pays the shipping cost.

We are committed to providing you with an unmatched level of customer service, quality, and reliability. If you cannot locate the specific product for your application or need additional product specifications, visit www.numatics.com or call 888-686-2842. Numatics Express orders cannot be canceled or adjusted once entered. Saturdays, Sundays, and Holidays are excluded.

†As industry requirements change, Numatics reserves the right to modify the contents of this catalog and program without notification. Updates on this program can be obtained from the Numatics website www.numatics.com or by calling 888-686-2842, or by contacting your local Numatics representative or distributor and referencing the Numatics Express program.

***Sentronic[®] Proportional Valves, CGT Compact Slides, NR Series Rodless and Air Bellows are limited to orders up to 5.**

****A Series Large Bore NFPA, ASP Series Steel Body NFPA and G Series Guide Rail Rodless are limited to orders up to 5.**

Welcome to the World of Fluid Automation...

Since 1945, Numatics has emerged as the prominent specialist in developing and manufacturing pneumatic and fluid power components for a widely diverse field of automated industry. From idea to implementation, leading engineers choose Numatics as their single source for:

- Quality Fluid Power components
- Technologically advanced design resources
- Quick response time in delivery and service from around the world

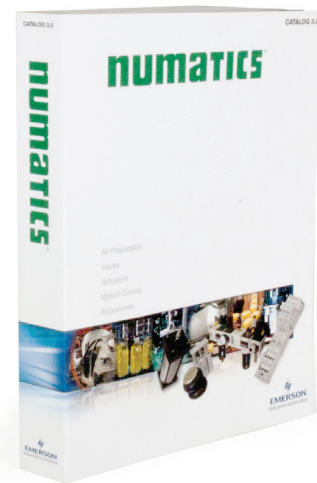

Numasizing®

Developed by Numatics, Numasizing® offers a whole new level of fluid power system optimization. Compare large amounts of component and process data against user objectives and industry benchmarks for the best possible size, pneumatic pressure, actuator stroke velocities and other part and process variable determinations.

CAD Modeling

Save critical development time with the most innovative CAD configuration program in the pneumatic component industry. Numatics in 3D eliminates the time consuming process associated with designing components from scratch based on information found in conventional paper catalogs.

The models are available in 85 different native CAD formats in 2D drawings and 3D models, including all the popular formats including Catia, I-DEAS, Pro/Engineer, SolidWorks, Unigraphics and more.

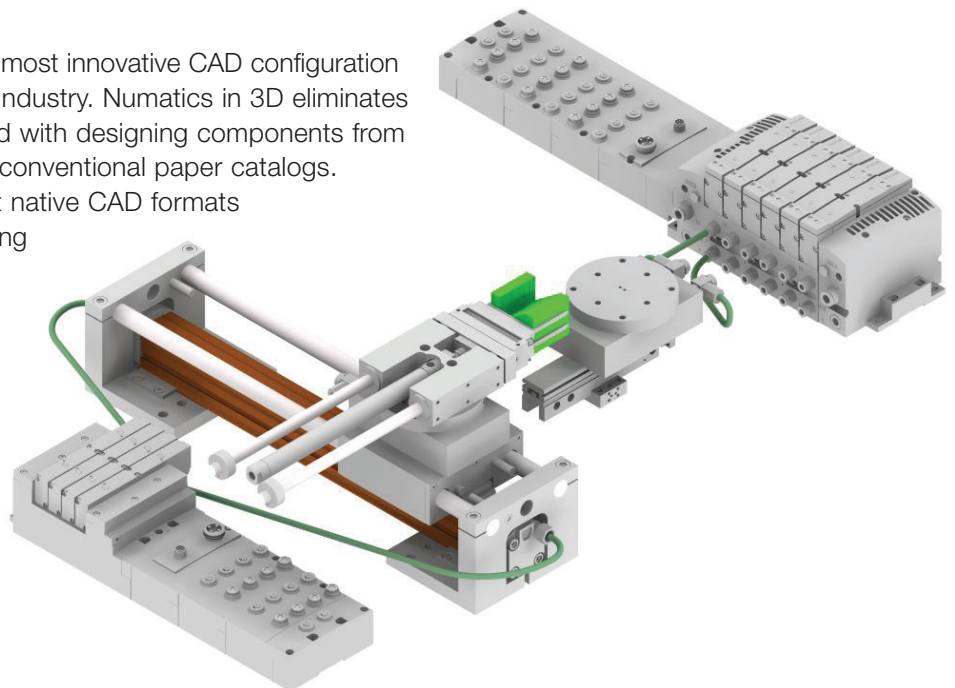

ii

Table of Contents

Actuator Sensor Series

NFPA Interchangeable Cylinders	2
Compact Cylinders	2-3
Non-Repairable Cylinders	4
ISO Standard Cylinders	4
Specialty Cylinders	5
Linear Slides	6
Rodless Cylinders	7
Specialty Actuator Products	8
Grippers	8-10
Rotary Actuators	10-11
Sensor Brackets	12
T-Slot Sensors	13-15
Quick Disconnect Cables	16
World Switch Hall Effect Part Numbers	16
Dove Tail Sensor with 45 Degree Wire	16
4mm Round Magnetic Sensors	17
CST Stopper Cylinder Magnetic Sensors	18
Proximity Sensors	19-21

NFPA Interchangeable Cylinders

A, EQ, F, & S Series (Tie Rod)

Bore	Bracket P/N
1 1/2"	P4995051680N001
2"	P4995051670N001
2 1/2"	P4995051670N001
3 1/4"	P499440617MN001
4"	P499440617MN001
5"	P4994406183N001
6"	P4994406183N001
8"	P4994406183N001
10"	P4995051660N001
12"	P4995051660N001
14"	P4995078930N001

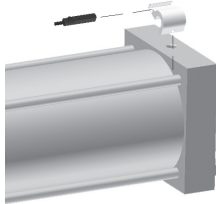

Sensor Description	Standard Cord Set	Quick Disconnect
Reed Switch	P494A0021300A00	P494A0021600A00
Hall PNP	P494A0022300A00	P494A0022600A00
Hall NPN	P494A0022400A00	P494A0022700A00

A & F Series (Profile Tube)

Bore	Bracket P/N
1 1/2"	P4994406190N001
2"	P4994406190N001
2 1/2"	P4994406190N001

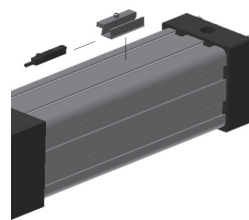

Sensor Description	Standard Cord Set	Quick Disconnect
Reed Switch	P494A0021300A00	P494A0021600A00
Hall PNP	P494A0022300A00	P494A0022600A00
Hall NPN	P494A0022400A00	P494A0022700A00

Compact Cylinders

C Series (Profile Tube) 2 in magnet code

Bore	Bracket P/N
3/4"	P4994406190N001
1 1/8"	P4994406190N001
1 1/2"	P4994406190N001
2"	P4994406190N001
2 1/2"	P4994406190N001

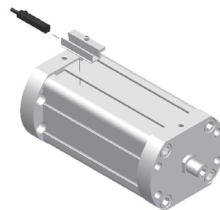

Sensor Description	Standard Cord Set	Quick Disconnect
Reed Switch	P494A0021300A00	P494A0021600A00
Hall PNP	P494A0022300A00	P494A0022600A00
Hall NPN	P494A0022400A00	P494A0022700A00

C Series (Profile Tube) 4 in magnet code

Direct Mount
No Bracket Required

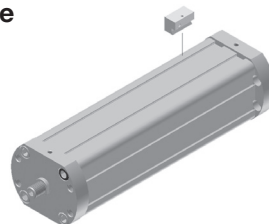

Sensor Description	Standard Cord Set	Quick Disconnect
Hall PNP	SH6-031	SH6-021
Hall NPN	SH6-032	SH6-022

C Series (Tie Rod) 2 in magnet code

Bore	Bracket P/N
3"	P4995051670N001
4"	P499440617MN001

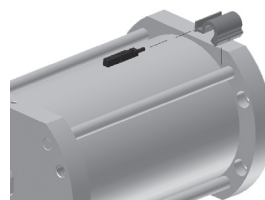

Sensor Description	Standard Cord Set	Quick Disconnect
Reed Switch	P494A0021300A00	P494A0021600A00
Hall PNP	P494A0022300A00	P494A0022600A00
Hall NPN	P494A0022400A00	P494A0022700A00

Compact Cylinders

C Series (Tie Rod) 4 in magnet code

Bore	Bracket P/N
3"	SB6-L01
3-1/4" - 4"	SB6-P01

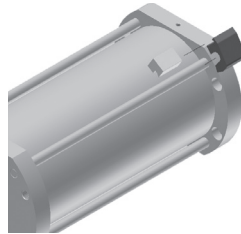

Sensor Description	Standard Cord Set	Quick Disconnect
Hall PNP	SH6-031	SH6-021
Hall NPN	SH6-032	SH6-022

NB Series

Bore	Bracket P/N
1/2"	SC-1
3/4"	SC-2
1 1/16"	SC-3
1 1/2"	SC-5
2"	SC-5
2 1/2"	SC-7
3"	SC-7
4"	SC-8

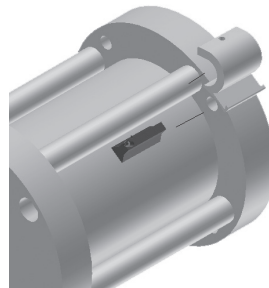

Sensor Description	Standard Cord Set	Quick Disconnect
Hall PNP	949-200-031	949-200-331
Hall NPN	949-200-032	949-200-332

Universal Series

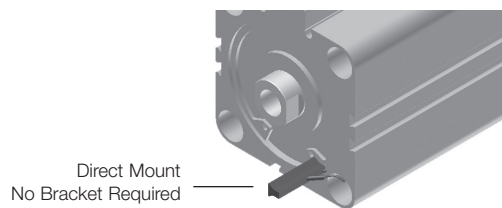

Sensor Description	Standard Cord Set	Quick Disconnect
Hall PNP	949-200-031	949-200-331
Hall NPN	949-200-032	949-200-332

Non-Repairable Cylinders

M Series

Bore	Bracket P/N
9/16"	P494AK129600A00
3/4"	P494AL129600A00
7/8"	P494AL129600A00
1 1/16"	P494A3129600A00
1 1/4"	P494A3129600A00
1 1/2"	P4995051700N001
1 3/4"	P494A4129600A00
2"	P494A4129600A00
2 1/2"	P4995051710N001
3"	P4995051720N001

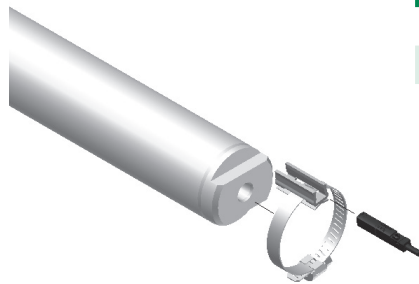

Sensor Description	Standard Cord Set	Quick Disconnect
Reed Switch	P494A0021300A00	P494A0021600A00
Hall PNP	P494A0022300A00	P494A0022600A00
Hall NPN	P494A0022400A00	P494A0022700A00

ISO Standard Cylinders

- 452 Series
- 453 Series
- 449 Series

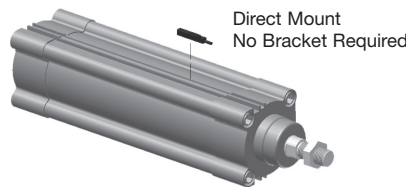

Sensor Description	Standard Cord Set	Quick Disconnect
Reed Switch	P494A0021300A00	P494A0021600A00
Hall PNP	P494A0022300A00	P494A0022600A00
Hall NPN	P494A0022400A00	P494A0022700A00

ISO VDMA (Tie Rod) Style, 450 Series

Bore	Bracket P/N
32mm	P4995051680N001
40mm	P4995051670N001
50mm	P499440617MN001
63mm	P499440617MN001
80mm	P499440617MN001
100mm	P499440617MN001
125mm	P4994406183N001
160mm	P4994406183N001
200mm	P4995051660N001

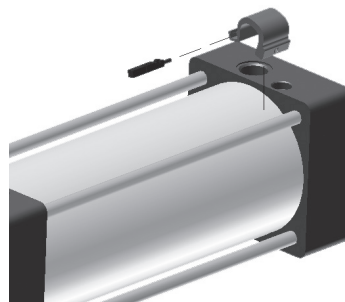

Sensor Description	Standard Cord Set	Quick Disconnect
Reed Switch	P494A0021300A00	P494A0021600A00
Hall PNP	P494A0022300A00	P494A0022600A00
Hall NPN	P494A0022400A00	P494A0022700A00

Specialty Cylinders

E Series (Tie Rod)

Bore	Bracket P/N
1 1/4"	P4995051680N001
1 3/4"	P4995051670N001
2"	P4995051680N001
2 1/2"	P4995051670N001
3"	P4995051670N001
3 1/2"	P499440617MN001
4 1/2"	P4994406183N001
5"	P4994406183N001
6"	P4994406183N001
8"	P4994406183N001

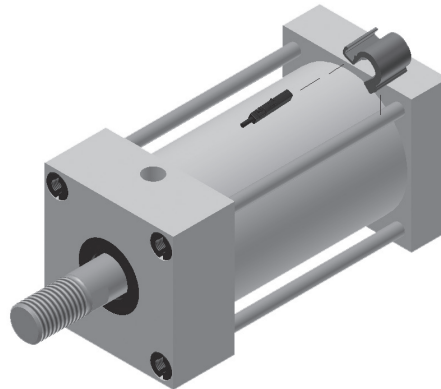

Sensor Description	Standard Cord Set	Quick Disconnect
Reed Switch	P494A0021300A00	P494A0021600A00
Hall PNP	P494A0022300A00	P494A0022600A00
Hall NPN	P494A0022400A00	P494A0022700A00

Tiny Titan Series (Profile)

Bore	Bracket P/N
3/4"	P4994406190N001
1"	P4994406190N001
1 1/8"	P4994406190N001

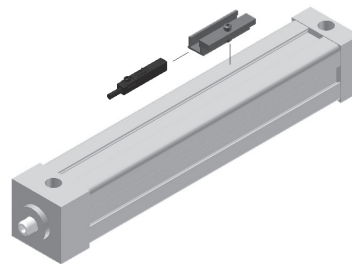

Sensor Description	Standard Cord Set	Quick Disconnect
Reed Switch	P494A0021300A00	P494A0021600A00
Hall PNP	P494A0022300A00	P494A0022600A00
Hall NPN	P494A0022400A00	P494A0022700A00

SH Series Slide, LC Series, LCX Series

Bore	Bracket P/N
SH056	P494AK129600A00
SH075	P494AL129600A00
SH106	P494A3129600A00
SH150	P4995051700N001
SH200	P494A4129600A00
SH250	P4995051710N001
SH300	P4995051720N001

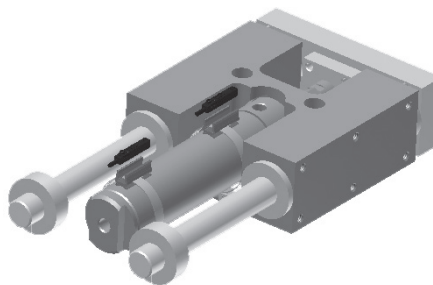

Sensor Description	Standard Cord Set	Quick Disconnect
Reed Switch	P494A0021300A00	P494A0021600A00
Hall PNP	P494A0022300A00	P494A0022600A00
Hall NPN	P494A0022400A00	P494A0022700A00

B Series Slide

BORE	BRACKET P/N
B04	P4994406190N001
B06	P4994406190N001
B08	P4994406190N001

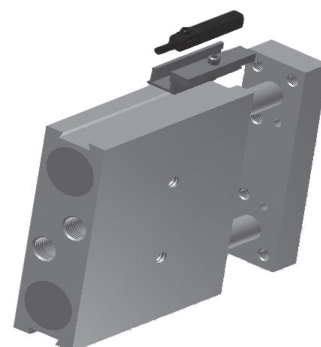

Sensor Description	Standard Cord Set	Quick Disconnect
Reed Switch	P494A0021300A00	P494A0021600A00
Hall PNP	P494A0022300A00	P494A0022600A00
Hall NPN	P494A0022400A00	P494A0022700A00

Linear Slides

CGT Series Slides

Direct Mount
No Bracket Required

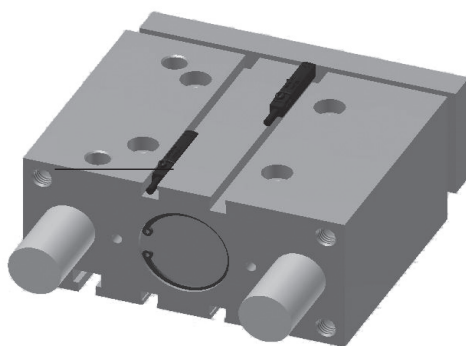

Sensor Description	Standard Cord Set	Quick Disconnect
Reed Switch	P4995051740N001	P4995058110N001
Hall PNP	P494A0022300A00	P494A0022600A00
Hall NPN	P494A0022400A00	P494A0022700A00

PST Series Slide

PST08 30mm stroke or less,
Only available with single position sensing

Direct Mount
No Bracket Required

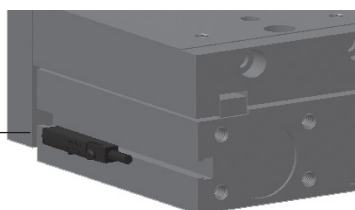

Sensor Description	Standard Cord Set	Quick Disconnect
Reed Switch	P494A0021300A00	P494A0021600A00
Hall PNP	P494A0022300A00	P494A0022600A00
Hall NPN	P494A0022400A00	P494A0022700A00

GS Series Gantry

Bore	Bracket P/N
GS075	P494AL129600A00
GS106	P494A3129600A00
GS150	P4995051700N001
GS200	P494A4129600A00

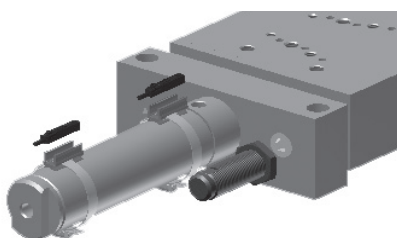

Sensor Description	Standard Cord Set	Quick Disconnect
Reed Switch	P494A0021300A00	P494A0021600A00
Hall PNP	P494A0022300A00	P494A0022600A00
Hall NPN	P494A0022400A00	P494A0022700A00

PBS Series Gantry

Direct Mount
No Bracket Required

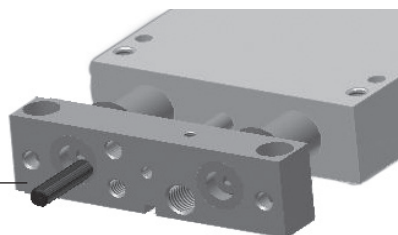

Sensor Description	Standard Cord Set	Quick Disconnect
Prox PNP	PROX-8FL2-PN	PROX-8QDS-PN
Prox NPN	PROX-8FL2-PN	PROX-8QDS-PN

Rodless Cylinders

Rodless Cylinder (S5)

Sensor Description	Standard Cord Set	Quick Disconnect
Reed Switch	P494A0021300A00	P494A0021600A00
Hall PNP	P494A0022300A00	P494A0022600A00
Hall NPN	P494A0022400A00	P494A0022700A00

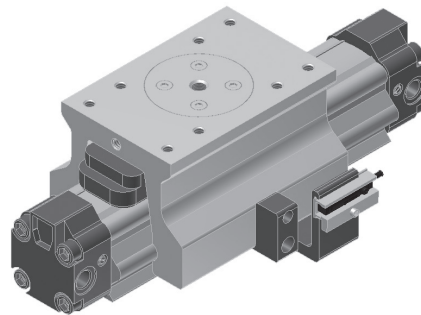

See Rodless catalog on how to order.

Rodless Cylinder (S1 and G Series)

Bore	Bracket P/N
25mm	US1RB
32mm	US1RB
40mm	US1RB
50mm	US1RB

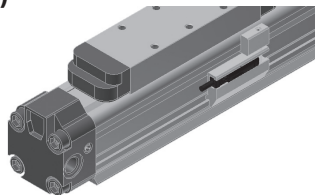

Sensor Description	Standard Cord Set	Quick Disconnect
Reed Switch	P494A0021300A00	P494A0021600A00
Hall PNP	P494A0022300A00	P494A0022600A00
Hall NPN	P494A0022400A00	P494A0022700A00

MCR (Magnetically Coupled Non-Guided)

Bore	Bracket P/N
12mm	P4995051680N001
16mm	P4995051680N001
20mm	P4995051680N001
25mm	P4995051680N001
32mm	P4995051680N001
40mm	P4995051680N001

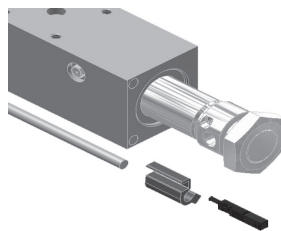

Sensor Description	Standard Cord Set	Quick Disconnect
Reed Switch	P494A0021300A00	P494A0021600A00
Hall PNP	P494A0022300A00	P494A0022600A00
Hall NPN	P494A0022400A00	P494A0022700A00

MCR (Magnetically Coupled Guided)

Bore	Bracket P/N
12mm	P4994406190N001
16mm	P4994406190N001
20mm	P4994406190N001
25mm	P4994406190N001
32mm	P4994406190N001
40mm	P4994406190N001

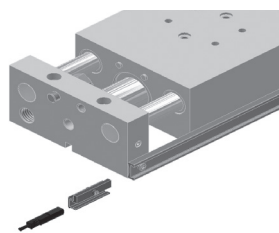

Sensor Description	Standard Cord Set	Quick Disconnect
Reed Switch	P494A0021300A00	P494A0021600A00
Hall PNP	P494A0022300A00	P494A0022600A00
Hall NPN	P494A0022400A00	P494A0022700A00

Also available with 8mm Prox sensor see page 21

Specialty Actuator Products

SC Series Swing Clamp

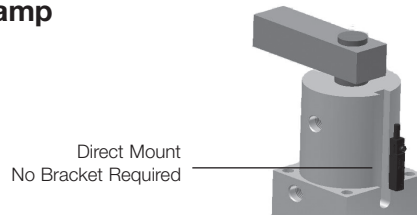

Sensor Description	Standard Cord Set	Quick Disconnect
Reed Switch	P4995051740N001	P4995058110N001
Hall PNP	P494A0022300A00	P494A0022600A00
Hall NPN	P494A0022400A00	P494A0022700A00

FE Series Feed Escapement

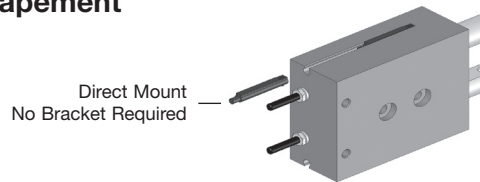

Sensor Description	Standard Cord Set	Quick Disconnect
Hall PNP	CS-20TP	CS-20TP-QD
Hall NPN	CS-20TN	CS-20TN-QD

CST Series Stopper Cylinder

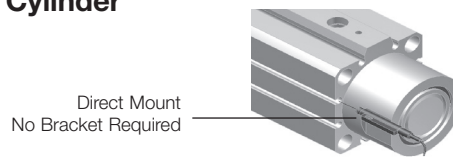

Sensor Description	Standard Cord Set	Quick Disconnect
Reed Switch	9C49-000-002	Not available
Hall PNP	9C49-000-031	9C49-000-331
Hall NPN	Not available	9C49-000-332

Grippers

NRG Series Gripper

Series	Bracket P/N
NRG010	P4994406190N001
NRG025	P4994406190N001
NRG050	P4994406190N001
NRG150	P4994406190N001

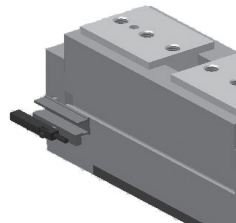

Sensor Description	Standard Cord Set	Quick Disconnect
Reed Switch	P494A0021300A00	P494A0021600A00
Hall PNP	P494A0022300A00	P494A0022600A00
Hall NPN	P494A0022400A00	P494A0022700A00

Grippers

PG Series Gripper

Series	Bracket P/N
PG	SB-PG

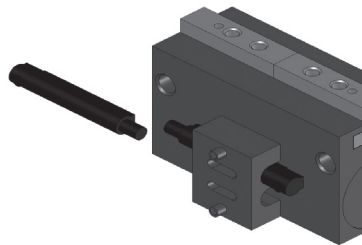

Sensor Description	Standard Cord Set	Quick Disconnect
Hall PNP	CS-18-TP	CSW-18T-QD
Hall NPN	CS-20TN	CS-18N-QD

See page 17 for sensor specifications

RPG Series Gripper

Series	Bracket P/N
RPG	CT-500

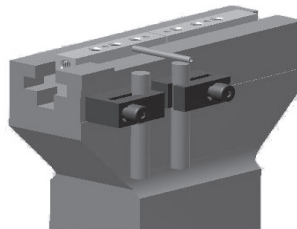

Sensor Description	Standard Cord Set	Quick Disconnect
Prox PNP	PROX-4FL2-P	PROX-4QDS-P
Prox NPN	PROX-4FL2-N	Not Available

See page 19 for sensor specifications

PG6J80 Series O-Ring Gripper

Series	Bracket P/N
PG6J80	N99-1202

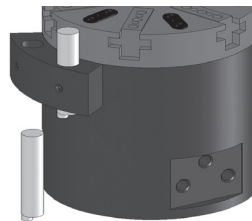

Sensor Description	Standard Cord Set	Quick Disconnect
Prox PNP	PROX-65FL2-PN	PROX-65QDS-P
Prox NPN	PROX-65FL2-PN	Not Available

TJ200 Series Gripper

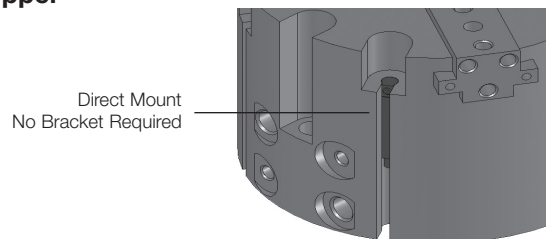

Sensor Description	Standard Cord Set	Quick Disconnect
Hall PNP	CS-18-TP	CSW-18T-QD
Hall NPN	CS-20TN	CS-18N-QD

GR1400 Series Gripper

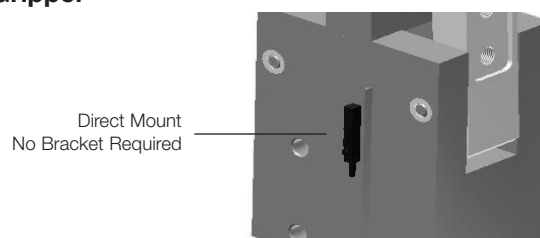

Sensor Description	Standard Cord Set	Quick Disconnect
Reed Switch	P494A0021300A00	P494A0021600A00
Hall PNP	P494A0022300A00	P494A0022600A00
Hall NPN	P494A0022400A00	P494A0022700A00

Grippers

GR90 Series Gripper

Series	Bracket P/N
GR90	CT-500

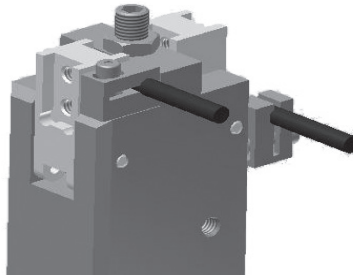

Sensor Description	Standard Cord Set	Quick Disconnect
Prox PNP	PROX-4FL2-P	PROX-4QDS-P
Prox NPN	PROX-4FL2-N	Not Available

WG Series Gripper

Series	Bracket P/N
WGS90	CT-500
WGL50	CT-500

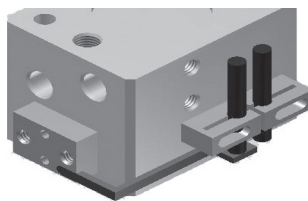

Sensor Description	Standard Cord Set	Quick Disconnect
Prox PNP	PROX-4FL2-P	PROX-4QDS-P
Prox NPN	PROX-4FL2-N	Not Available

WBG Series Gripper

Series	Bracket P/N
WBG	CT-500

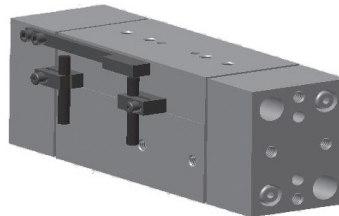

Sensor Description	Standard Cord Set	Quick Disconnect
Prox PNP	PROX-4FL2-P	PROX-4QDS-P
Prox NPN	PROX-4FL2-N	Not Available

Rotary Actuators

R Series Rotary (Profile)

Series	Bracket P/N
1"	P4994406190N001
1 1/2"	P4994406190N001
2"	P4994406190N001
2 1/2"	P4994406190N001
3 1/4"	P4994406190N001

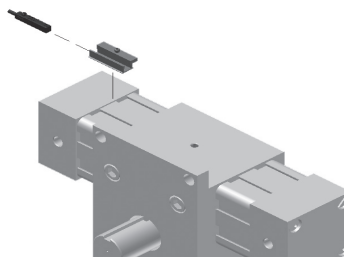

Sensor Description	Standard Cord Set	Quick Disconnect
Reed Switch	P494A0021300A00	P494A0021600A00
Hall PNP	P494A0022300A00	P494A0022600A00
Hall NPN	P494A0022400A00	P494A0022700A00

Rotary Actuators

AR Series Rotary

Series	Bracket P/N
AR020	P4994406190N001
AR025	P4994406190N001
AR032	P4994406190N001

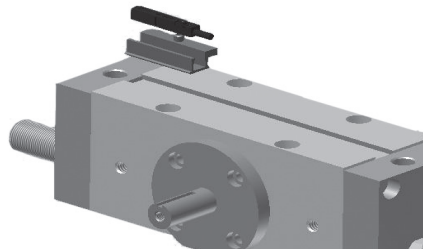

Sensor Description	Standard Cord Set	Quick Disconnect
Reed Switch	P494A0021300A00	P494A0021600A00
Hall PNP	P494A0022300A00	P494A0022600A00
Hall NPN	P494A0022400A00	P494A0022700A00

RW Series Rotary

Series	Bracket P/N
RW030	P4994406190N001
RW075	P4994406190N001
RW125	P4994406190N001

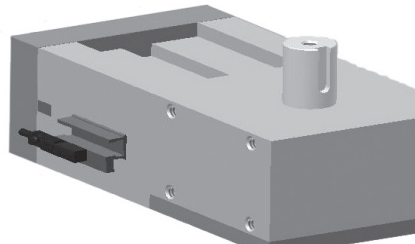

Sensor Description	Standard Cord Set	Quick Disconnect
Reed Switch	P494A0021300A00	P494A0021600A00
Hall PNP	P494A0022300A00	P494A0022600A00
Hall NPN	P494A0022400A00	P494A0022700A00

LR Series Rotary

Series	Bracket P/N
LR06	RSH05
LR20	RSH05
LR60	RSH05
LR125	RSH05

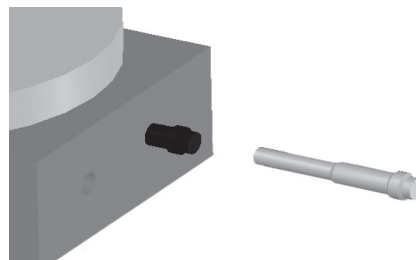

Sensor Description	Standard Cord Set	Quick Disconnect
Prox PNP	PROX-5FL2-P	PROX-5QDS-P
Prox NPN	PROX-5FL2-N	Not Available

RM Series Rotary

Series	Bracket P/N
RM1	RSH05
RM2	RSH05
RM3	RSH05
RM4	RSH05
RM5	RSH05
RM6	RSH05
RM8	RSH05
RM9	RSH05

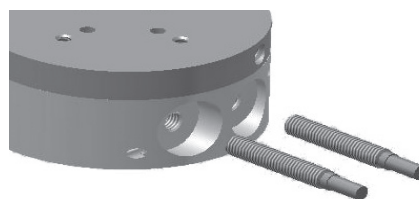

Sensor Description	Standard Cord Set	Quick Disconnect
Prox PNP	PROX-5FL2-P	PROX-5QDS-P
Prox NPN	PROX-5FL2-N	Not Available

Sensing Brakcet

Tie Rod Bracket

Bracket P/N

- P4995051680N001
- P4995051670N001
- P499440617MN001
- P4994406183N001
- P4995051660N001
- P4995078930N001



Non-Repairable Bracket

Bracket P/N

- P494AK129600A00
- P494AL129600A00
- P494A3129600A00
- P4995051700N001
- P494A4129600A00
- P4995051710N001
- P4995051720N001



B Square Tie Rod Bracket

Bracket P/N

- 900-F00-000
- 900-G00-000
- 900-H00-000

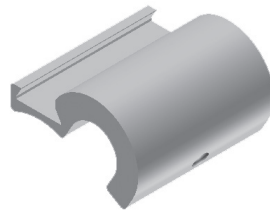

C Series (Tie Rod) 4 in magnet code

Bracket P/N

- SB6-L01
- SB6-P01

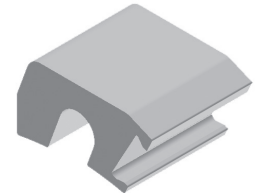

1/2" Dove Tail Bracket

Bracket P/N

- P4994406190N001

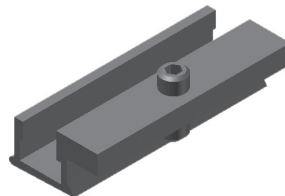

NB Series (Tie Rod) Bracket

Bracket P/N

- SC-1
- SC-2
- SC-3
- SC-5
- SC-7
- SC-8

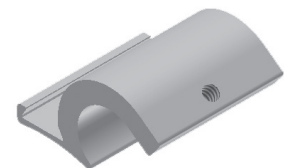

4mm Prox Bracket

Bracket P/N

- CT-500

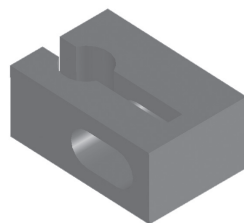

S1, G Series Rodless Cylinder Bracket

Bracket P/N

- US1RB

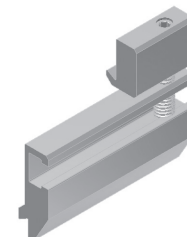

5mm Prox Housing

Bracket P/N

- RSH05

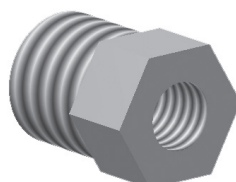

S5 Rodless Cylinder Bracket

Bracket P/N

See Rodless catalog

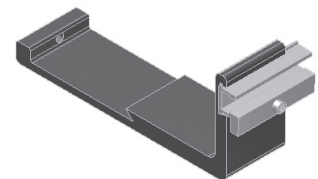

PG Series Gripper

Bracket P/N

- SB-PG

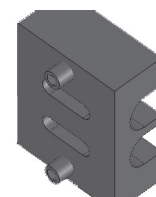

Sensing Part Numbers

P494A0022300A00

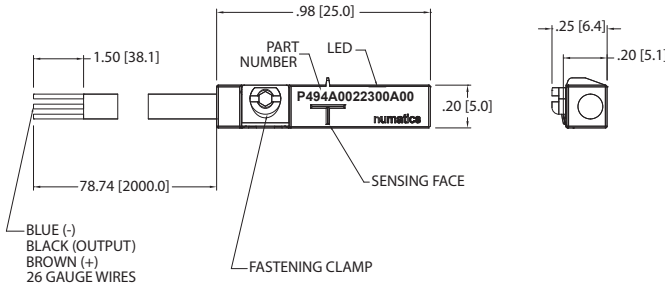

P494A0022600A00

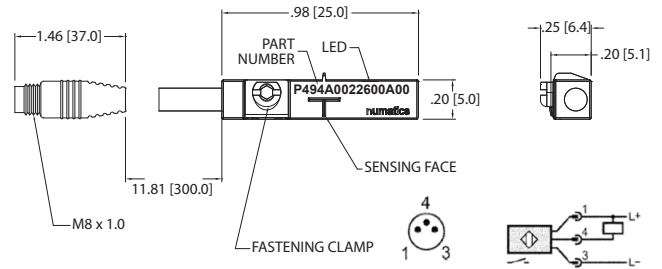

ELECTRICAL DESIGN	DC PNP
OUTPUT	Normally Open
OPERATING VOLTAGE	10-30 VDC
CURRENT RATING	100 mA
SHORT-CIRCUIT PROTECTION	Yes
OVERLOAD PROTECTION	Yes
REVERSE POLARITY PROTECTION	Yes
VOLTAGE DROP	< 2.5 V
CURRENT CONSUMPTION	< 12 mA
REPEATABILITY	< .2mm
POWER-ON DELAY TIME	< 30 ms
SWITCH FREQUENCY	> 3000 Hz
AMBIENT TEMPERATURE	-25°C to 85°C
PROTECTION	IP 67, III
HYSTERESIS	1.0mm
MAGNETIC SENSITIVITY	2.0 mT
TRAVEL SPEED	> 10 m/s

HOUSING MATERIAL PA (Polyamide) Black; Fastening Clamp: Stainless Steel

FUNCTION DISPLAY SWITCHING STATUS Yellow LED

CONNECTION Flying Leads, Pur Cable (2m Long, 3 x26 Gauge Wire)

REMARKS Clamping Screw with Combined Slot/Hexagon Socket Head AF 1.5
cULus - Class 2 Source Required

ACCESSORIES Rubber Placeholder, Cable Clip, and Cut Sheet To Be Provided with Every Switch

AGENCY APPROVALS   

ELECTRICAL DESIGN	DC PNP
OUTPUT	Normally Open
OPERATING VOLTAGE	10-30 VDC
CURRENT RATING	100 mA
SHORT-CIRCUIT PROTECTION	Yes
OVERLOAD PROTECTION	Yes
REVERSE POLARITY PROTECTION	Yes
VOLTAGE DROP	< 2.5 V
CURRENT CONSUMPTION	< 12 mA
REPEATABILITY	< .2mm
POWER-ON DELAY TIME	< 30 ms
SWITCH FREQUENCY	> 3000 Hz
AMBIENT TEMPERATURE	-25°C to 85°C
PROTECTION	IP 67, III
HYSTERESIS	1.0mm
MAGNETIC SENSITIVITY	2.0 mT
TRAVEL SPEED	> 10 m/s

HOUSING MATERIAL PA (Polyamide) Black; Fastening Clamp: Stainless Steel

FUNCTION DISPLAY SWITCHING STATUS Yellow LED

CONNECTION M8 Connector, Pur Cable (.3 m)

REMARKS Clamping Screw with Combined Slot/Hexagon Socket Head AF 1.5
cULus - Class 2 Source Required

ACCESSORIES Rubber Placeholder, Cable Clip, and Cut Sheet To Be Provided with Every Switch

AGENCY APPROVALS   

Sensing Part Numbers

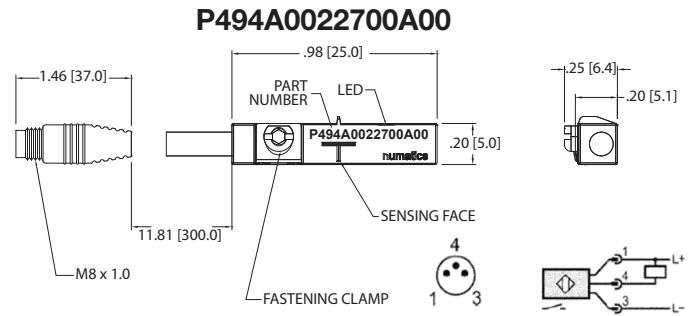
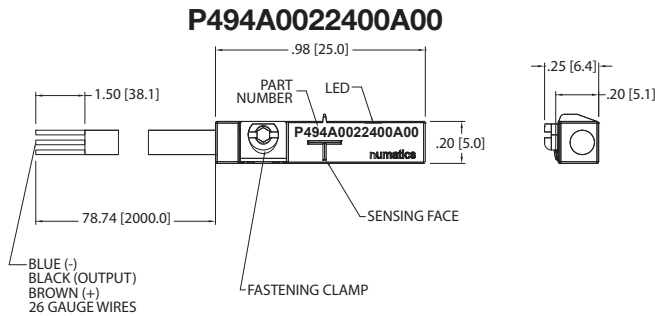

ELECTRICAL DESIGN	DC NPN
OUTPUT	Normally Open
OPERATING VOLTAGE	10-30 VDC
CURRENT RATING	100 mA
SHORT-CIRCUIT PROTECTION	Yes
OVERLOAD PROTECTION	Yes
REVERSE POLARITY PROTECTION	Yes
VOLTAGE DROP	< 2.5 V
CURRENT CONSUMPTION	< 12 mA
REPEATABILITY	< .2mm
POWER-ON DELAY TIME	< 30 ms
SWITCH FREQUENCY	> 3000 Hz
AMBIENT TEMPERATURE	-25°C to 85°C
PROTECTION	IP 67, III
HYSTERESIS	1.0mm
MAGNETIC SENSITIVITY	2.0 mT
TRAVEL SPEED	> 10 m/s

HOUSING MATERIAL PA (Polyamide) Black; Fastening Clamp: Stainless Steel

FUNCTION DISPLAY SWITCHING STATUS Yellow LED

CONNECTION Flying Leads, Pur Cable (2m Long, 3 x26 Gauge Wire)

REMARKS Clamping Screw with Combined Slot/Hexagon Socket Head AF 1.5
cULus - Class 2 Source Required

ACCESSORIES Rubber Placeholder, Cable Clip, and Cut Sheet To Be Provided with Every Switch

AGENCY APPROVALS   

ELECTRICAL DESIGN	DC NPN
OUTPUT	Normally Open
OPERATING VOLTAGE	10-30 VDC
CURRENT RATING	100 mA
SHORT-CIRCUIT PROTECTION	Yes
OVERLOAD PROTECTION	Yes
REVERSE POLARITY PROTECTION	Yes
VOLTAGE DROP	< 2.5 V
CURRENT CONSUMPTION	< 12 mA
REPEATABILITY	< .2mm
POWER-ON DELAY TIME	< 30 ms
SWITCH FREQUENCY	> 3000 Hz
AMBIENT TEMPERATURE	-25°C to 85°C
PROTECTION	IP 67, III
HYSTERESIS	1.0mm
MAGNETIC SENSITIVITY	2.0 mT
TRAVEL SPEED	> 10 m/s

HOUSING MATERIAL PA (Polyamide) Black; Fastening Clamp: Stainless Steel

FUNCTION DISPLAY SWITCHING STATUS Yellow LED

CONNECTION M8 Connector, Pur Cable (.3 m)

REMARKS Clamping Screw with Combined Slot/Hexagon Socket Head AF 1.5
cULus - Class 2 Source Required

ACCESSORIES Rubber Placeholder, Cable Clip, and Cut Sheet To Be Provided with Every Switch

AGENCY APPROVALS   

Sensing Part Numbers

P494A0021300A00
P4995051740N001

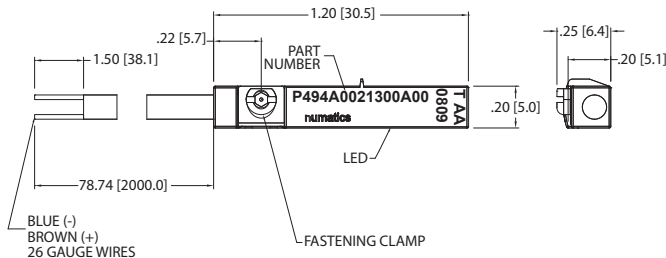

P494A0021600A00
P4995058110N001

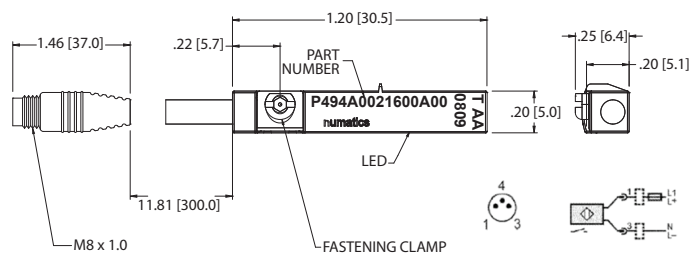

ELECTRICAL DESIGN	AC/DC REED
OUTPUT	Normally Open
OPERATING VOLTAGE	5-120 VAC/DC
CURRENT RATING	100 mA*
SHORT-CIRCUIT PROTECTION	No
OVERLOAD PROTECTION	No
REVERSE POLARITY PROTECTION	Yes
VOLTAGE DROP	< 5 V
REPEATABILITY	± .2mm
MAKETIME INCLUDING BOUNCE	< .6 ms
BREAKTIME	< .1 ms
SWITCHING POWER (MAX)	5 W
SWITCH FREQUENCY	1000 Hz
AMBIENT TEMPERATURE	-25°C to 70°C
PROTECTION	IP 67, II
HYSTERESIS	.9mm
HOUSING MATERIAL	PA (Polyamide) Black; Fastening Clamp: Stainless Steel
FUNCTION DISPLAY SWITCHING STATUS	Yellow LED
CONNECTION	Flying Leads, Pur Cable (2m Long, 2 x26 Gauge Wire)

REMARKS

*External Protective Circuit for Inductive Load (Valve, Contactor, Etc.) Necessary. Conforms to 2008 NEC Section 725 III, Class 2 Circuits

Clamping Screw with Combined Slot/Hexagon Socket Head AF 1.5.
No LED Function in case of Polarity in DC Operation

ACCESSORIES

Rubber Placeholder, Cable Clip, and Cut Sheet To Be Provided with Every Switch

AGENCY APPROVALS



ELECTRICAL DESIGN	AC/DC REED
OUTPUT	Normally Open
OPERATING VOLTAGE	5-60 VDC / 5-50 VAC #
CURRENT RATING	100 mA*
SHORT-CIRCUIT PROTECTION	No
OVERLOAD PROTECTION	No
REVERSE POLARITY PROTECTION	Yes
VOLTAGE DROP	< 5 V
REPEATABILITY	± .2mm
MAKETIME INCLUDING BOUNCE	< .6 ms
BREAKTIME	< .1 ms
SWITCHING POWER (MAX)	5 W
SWITCH FREQUENCY	1000 Hz
AMBIENT TEMPERATURE	-25°C to 70°C
PROTECTION	IP 67, II
HYSTERESIS	.9mm
HOUSING MATERIAL	PA (Polyamide) Black; Fastening Clamp: Stainless Steel
FUNCTION DISPLAY SWITCHING STATUS	Yellow LED
CONNECTION	M8 Connector, Pur Cable (.3m)

REMARKS

*External Protective Circuit for Inductive Load (Valve, Contactor, Etc.) Necessary. Conforms to 2008 NEC Section 725 III, Class 2 Circuits

M8 Connector voltage limited to 5-60 VDC/ 5-50 VAC to conform with 2008 IEC 61076-2-104

Clamping Screw with Combined Slot/Hexagon Socket Head AF 1.5.
No LED Function in case of Polarity in DC Operation

ACCESSORIES

Rubber Placeholder, Cable Clip, and Cut Sheet To Be Provided with Every Switch

AGENCY APPROVALS



Quick Disconnect Cables

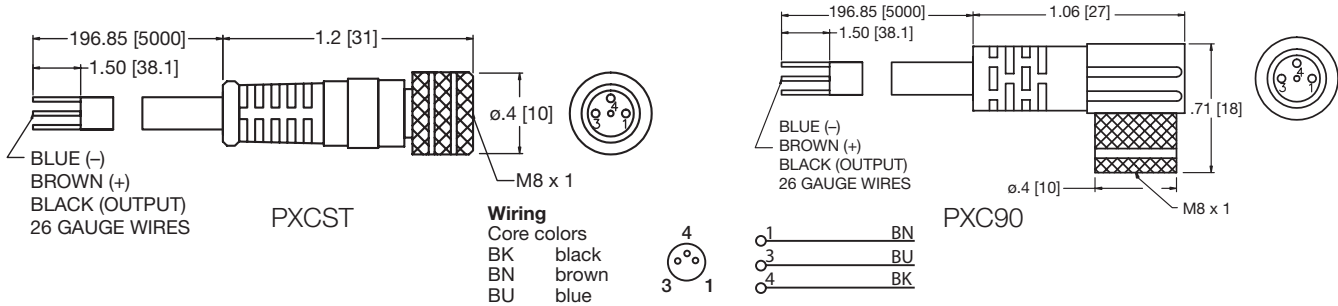

Order Code	Type	Operating Voltage	Current Rating	Cable Material	Protection	Connector
PXCST	Straight 5 m Cable (3 x 26 Gauge wire)	60 AC/75 DC	3 A	PUR	IP 68, III	M8
PXC90	90° 5 m Cable (3 x 26 Gauge wire)	60 AC/75 DC	3 A	PUR	IP 68, III	M8

World Switch Hall Effect Part Numbers

P/N	Switch Style	Switch Type	Function	Switching Voltage	Switching Current	Switching Power	Voltage Drop
SH6-031	3m Wire Version	Hall Effect for Reed Magnet & Light Sourcing	Normally Open Sourcing (PNP)	6-24 VDC	0.3 Amps Max.	7.2 Watts Max.	0.5 Volts
SH6-021	8m Connector Pigtail	Hall Effect for Reed Magnet & Light Sourcing	Normally Open Sourcing (PNP)	6-24 VDC	0.3 Amps Max.	7.2 Watts Max.	0.5 Volts
SH6-032	3m Wire Version	Hall Effect for Reed Magnet & Light Sourcing	Normally Open Sourcing (NPN)	6-24 VDC	0.3 Amps Max.	7.2 Watts Max.	0.5 Volts
SH6-022	8m Connector Pigtail	Hall Effect for Reed Magnet & Light Sourcing	Normally Open Sourcing (NPN)	6-24 VDC	0.3 Amps Max.	7.2 Watts Max.	0.5 Volts

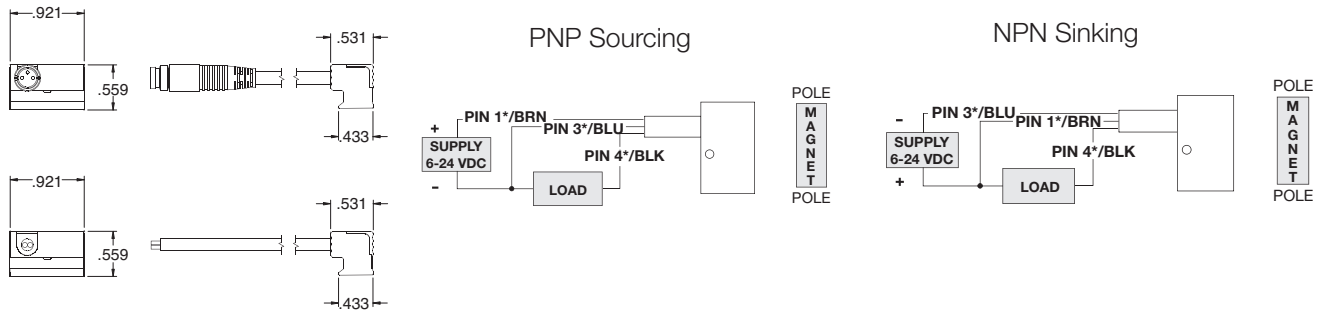

Dove tail Sensor with 45 Degree Wire

- Encased in a plastic housing, dovetail style electronic sensors are corrosion resistant. 45° wire outlet allows close mounting.

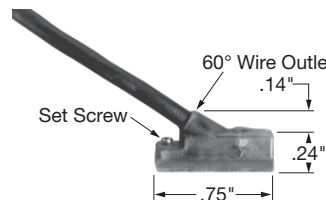

Dovetail Style Magnetic Sensor with LED

Sensor Type	Standard Cord Set	Quick Disconnect	Electrical Characteristics
Electronic	949-200-031	949-200-331	Sourcing PNP 6-24 VDC, 0.20 Amp Max current, 0.5 Voltage Drop
Electronic	949-200-032	949-200-332	Sinking NPN 6-24 VDC, 0.20 Amp Max current, 0.5 Voltage Drop

*Note: Quick disconnect styles are supplied with 6 inch pigtail with male connector. Order female cordsets separately.

Sensor Temperature Range
-20° to +80° C (-4° to +176° F)

Electro Switch (NPN NO) Flying Lead - CS-20TN

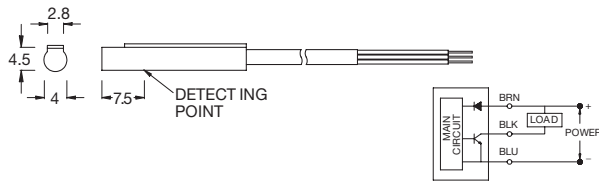

Sensor Type	Solid State Output
Switching Logic	Normally Open
Output	NPN Current Sourcing
Operating Voltage	5-30 VDC
Switching Current	50mA max.
Power Rating*	1.5 Watts
Voltage Drop	0.5 V @ 25 mA max.
Current Consumption	12 mA @ 24 VDC max.
Leakage Current	0.01 mA max.
LED Indicator	Red
Cable	-
Operating Frequency	1000 Hz
Magnetic Requirement	40 Gauss parallel
Temperature Range	14 to 158°F (-10 to 70°C)
Shock / Vibration	50G/9G
Enclosure Classification	IEC 529 IP67 (NEMA 6)
Protection Circuit	Reverse Polarity, Surge Suppression
Set Screw Max. Torque	1.77 in-lbs (0.2 N-m)

Electro Switch (NPN NO) Flying Lead - CS-18-TP

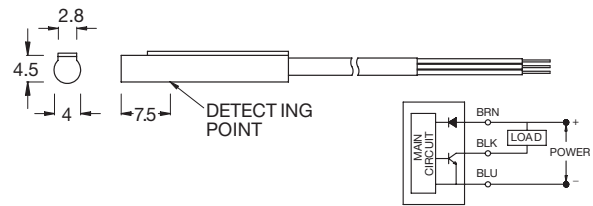

Sensor Type	Solid State Output
Switching Logic	Normally Open
Output	NPN Current Sourcing
Operating Voltage	5-30 VDC
Switching Current	50mA max.
Power Rating*	1.5 Watts
Voltage Drop	0.5 V @ 25 mA max.
Current Consumption	12 mA @ 24 VDC max.
Leakage Current	0.01 mA max.
LED Indicator	Red
Cable	-
Operating Frequency	1000 Hz
Magnetic Requirement	40 Gauss parallel
Temperature Range	14 to 158°F (-10 to 70°C)
Shock / Vibration	50G/9G
Enclosure Classification	IEC 529 IP67 (NEMA 6)
Protection Circuit	Reverse Polarity, Surge Suppression
Set Screw Max. Torque	1.77 in-lbs (0.2 N-m)

Sensor Dimensions
(mm unless noted)

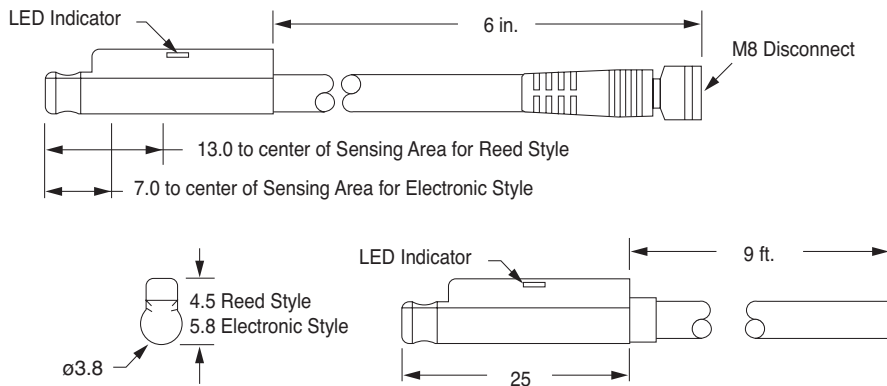

All sensors feature surge suppression, polarity protection, LED indicator, and extremely fast switching speeds.

Sensor Type	Function	Switching Voltage	Switching Current	Switching Power	Switching Speed	Voltage Drop	Standard Cord Set	Quick Connect Part No.
Reed Switch for PLC's w/LED (current limiting)	SPST Normally Open	50 - 60 VAC/DC	0.04 Amp max. 0.005 Amp min.	4 Watts max.	0.5 ms operate 0.1 ms release	2.5 Volts	9C49-000-002	9C49-000-302 Requires 3 pin cordset
Electronic LED and Sourcing	PNP Normally Open	6-30 VDC	0.2 Amp max.	6 Watts max.	1.5µs operate 0.5µs release	1.5 Volts	9C49-000-031	9C49-000-331 Requires 3 pin cordset
Electronic LED and Sinking	NPN Normally Open	6-30 VDC	0.2 Amp max.	6 Watts max.	1.5µs operate 0.5µs release	1.5 Volts	9C49-000-032	9C49-000-332 Requires 3 pin cordset

Prox Switch (NPN NO) Flying Lead - PROX-4FL2-N Prox Switch (PNP NO) Flying Lead - PROX-4FL2-P

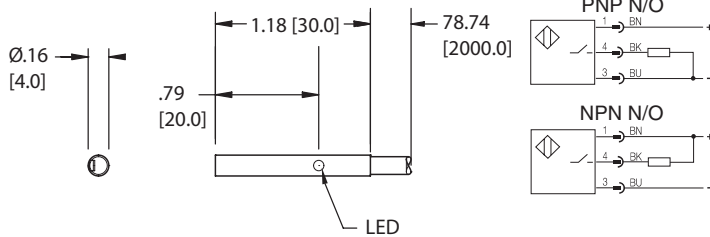

Electrical Design	3-Wire DC PNP/NPN
Output	Normally Open
Operating Voltage	10-36 VDC
Current Rating	100 mA
Short-Circuit Protection	Yes (Non-Latching)
Overload Protection	Yes
Reverse Polarity Protection	Yes
Voltage Drop	< 2.5V
Current Consumption	< 15 mA @ 24V
Real Sensing Range	.8mm ± 10%
Switching Frequency	> 2000 Hz
Ambient Temperature	-25°C to 70°C
Protection	IP 65, III
Switch-Point Drift	-10 - 10% OF Sr
Hysteresis	1 - 15% OF Sr
Operating Distance	0 - .65mm
Correction Factor	Mild Steel=.1, Stainless Steel=.7, Brass=.5, Alum.=.4, Copper=.3
Housing Material	Housing; Stainless Steel: POM
Function Display	Yellow LED
Switching Status	PVC Cable, 2m, 3 x .14mm2
Connection	

Prox Switch (PNP NO), 8 mm connector - PROX-4QDS-P

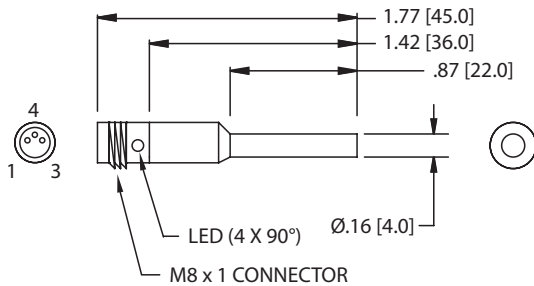

Mechanical Data	IP 65
Degree of protection per IEC 529	stainless steel
Housing material	POM
Material of sensing face	M8 Connector
Connection	
Approvals	



Prox Switch (NPN NO) Flying Lead - PROX-5FL2-N Prox Switch (PNP NO) Flying Lead - PROX-5FL2-P

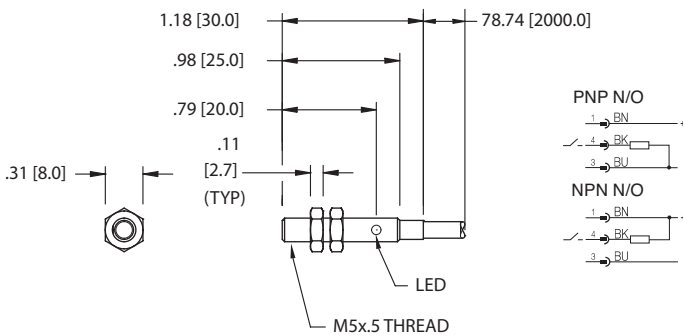

Electrical Design	3-Wire DC PNP/NPN
Output	Normally Open
Operating Voltage	10-36 VDC
Current Rating	100 mA
Short-Circuit Protection	Yes (Non-Latching)
Overload Protection	Yes
Reverse Polarity Protection	Yes
Voltage Drop	< 2.5V
Current Consumption	< 15 mA @ 24V
Real Sensing Range	.8mm ± 10%
Switching Frequency	> 2000 Hz
Ambient Temperature	-25°C to 70°C
Protection	IP 65, III
Switch-Point Drift	-10 - 10% OF Sr
Hysteresis	1 - 15% OF Sr
Operating Distance	0 - .65mm
Correction Factor	Mild Steel=.1, Stainless Steel=.7, Brass=.5, Alum.=.4, Copper=.3
Housing Material	Housing; Stainless Steel: POM
Function Display	Red LED
Switching Status	PVC Cable, 2m, 3 x .14mm2
Connection	

Prox Switch (PNP NO) 8 mm connector - PROX-5QDS-P

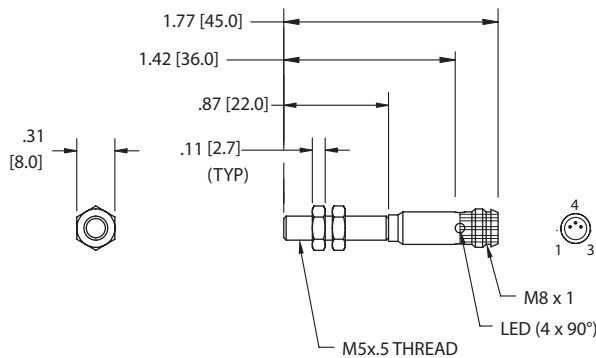

Mechanical Data

Degree of protection per IEC 529
Housing material
Material of sensing face
Connection
Approvals

IP 65
stainless steel
POM
M8 Connector



Prox Switch (PNP & NPN NO) Flying Leads - PROX-65FL2-PN

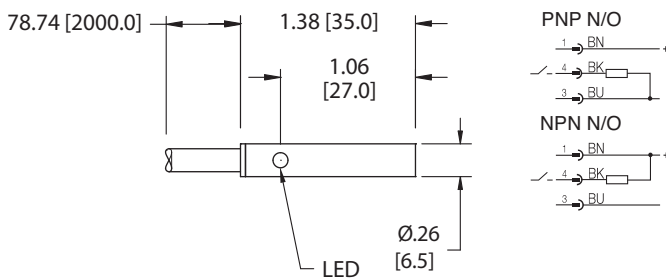

Electrical Design

Output
Operating Voltage
Current Rating
Minimum Load Current
Leakage Current
Short Circuit Protection
Overload Protection
Reverse Polarity Protection
Voltage Drop
Real Sensing Range
Switching Frequency
Ambient Temperature
Protection
Switch-Point Drift
Hysteresis
Operating Distance
Correction Factor

DC PNP/NPN
Normally Open
10-36 VDC
200 mA
4 mA
< .8mA
No
No
No
< 2.6V
1mm ± 10%
> 900 Hz
-25°C to 80°C
IP 67
-10 - 10% OF Sr
1 - 15% OF Sr
0 - .8mm



Housing Material
Function Display Switching Status
Connection

Mild Steel=1, Stainless Steel=.7,
Brass=.5, Alum.=.4, Copper=.3
Yellow LED
PVC Cable, 2m, 3 x .14mm2

Prox Switch (PNP NO) 8 mm connector - PROX-65QDS-P

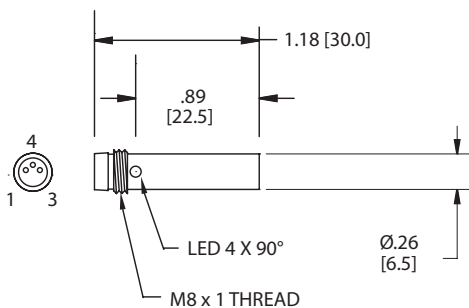

Mechanical Data

Degree of protection per IEC 529
Housing material
Material of sensing face
Connection
Approvals

IP 65
stainless steel
PA 12
M8 Connector
cULus



Prox Switch (PNP & NPN NO) Flying Leads - PROX-8FL2-PN

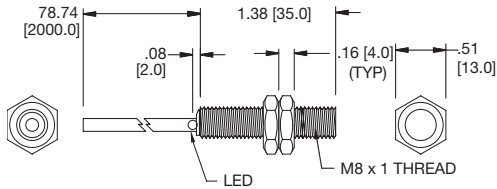

PNP N/O

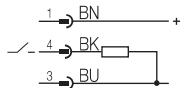

NPN N/O

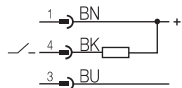

Electrical Design

Output

Operating Voltage
Current Rating
Minimum Load Current
Leakage Current
Short Circuit Protection
Overload Protection
Reverse Polarity Protection
Voltage Drop
Current Consumption
Switching Frequency
Ambient Temperature
Protection
Hysteresis
Operating Distance
Correction Factor

Housing Material
Function Display Switching Status
Connection
REMARKS

3-Wire DC PNP;
2-Wire DC PNP/NPN
Normally Open
10-30 VDC
100 mA
2 mA*
< .5 mA
Yes (Non-Latching)
Yes
Yes
< 2.8V
< 10 mA**
> 1000 Hz
0°C to 70°C
IP 67, III
1 - 15% OF Sr
0 - 2.4mm
Mild Steel=1, Stainless Steel=.7,
Brass=.5, Alum.=.4, Copper=.3
Brass with Bronze Coated
Yellow LED
PVC Cable, 2m, 3 x .14mm2
*ONLY IN 2-WIRE OPERATION
**ONLY IN 3-WIRE OPERATION

Prox Switch (PNP & NPN NO) 8 mm connector - PROX-8QDS-PN

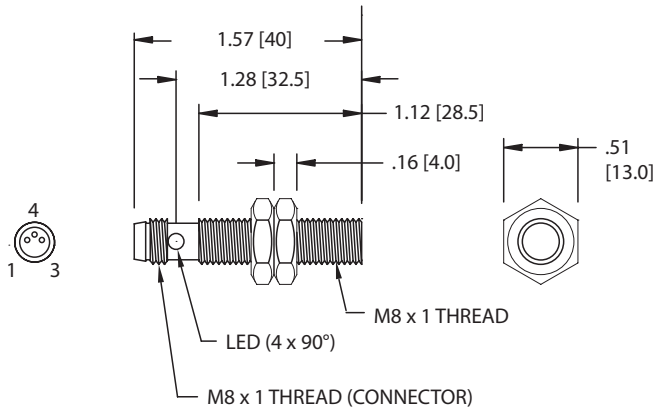

Mechanical Data

Degree of protection per IEC 529
Housing material
Material of sensing face
Connection
Approvals

IP 67
stainless steel
PBTP
M8
cULus



PNP N/O

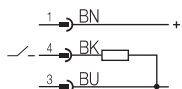

NPN N/O

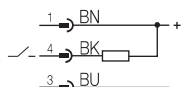



World Class Supplier of Pneumatic Components



World Headquarters

USA Numatics, Incorporated

46280 Dylan Drive
Novi, Michigan 48377

P: 248-596-3200
F: 248-596-3201

Canada Numatics, Ltd

P: 519-758-2700
F: 519-758-5540

México - Ascomatica SA de CV

P: 52 55 58 09 56 40 (DF y Area metropolitana)
P: 01 800 000 2726 (Interior de la República)
F: 52 55 58 09 56 60

Brazil Ascoval Ind.e Comercio Ltda

P: (55) 11-4208-1700
F: (55) 11-4195-3970

